



# 1 Final publishable summary report

## Content

<b>1</b>	<b>Final publishable summary report .....</b>	<b>1</b>
<b>1.1</b>	<b>Executive summary .....</b>	<b>3</b>
<b>1.2</b>	<b>A summary description of project context and objectives ....</b>	<b>5</b>
<b>1.3</b>	<b>A description of the main S&amp;T results/foregrounds .....</b>	<b>12</b>
<b>1.3.1</b>	<b>Work package 1: Clinical trial .....</b>	<b>13</b>
1.3.1.1	T 1.1: Development of two study protocols for SR and HR patients.....	13
1.3.1.2	T 1.2: Set up contract agreements between participating parties.....	17
1.3.1.3	T 1.3: Set up and conduct systematic monitoring/source data verification .....	18
1.3.1.4	T 1.4: Production, labelling and delivery of Epratuzumab .....	18
1.3.1.5	T 1.5: Centre recruitment.....	19
1.3.1.6	T 1.6: Scientific advice, consultation and submission to regulatory authorities.....	19
1.3.1.7	T 1.7: Recruitment and documentation of SR and HR patients.....	20
1.3.1.8	T 1.8: Set up and realization of central pharmacovigilance, safety reports.....	22
1.3.1.9	T 1.9: Pharmacokinetic and -dynamic monitoring of Epratuzumab .....	22
<b>1.3.2</b>	<b>Work package 2: Database and statistics .....</b>	<b>22</b>
1.3.2.1	T 2.1: Planning and programming of the IntReALL SR and HR study database.....	22
1.3.2.2	T 2.2: Set up of a statistical model and analysis plan for the IntReALL SR and HR trial.....	23
1.3.2.3	T 2.3: Instruction courses and follow-up hosting of Marvin database .....	23
1.3.2.4	T 2.4: Optimization of the MARVIN system for international paediatric oncology trials.....	24
1.3.2.5	T 2.5: Perform interim and final analyses .....	27
1.3.2.6	T 2.6: Planning publications of the results.....	27
<b>1.3.3</b>	<b>Work package 3: Diagnostics and biological research.....</b>	<b>28</b>
1.3.3.1	T 3.1 Standardization of diagnostics and monitoring in IntReALL .....	28
1.3.3.2	T 3.2: Standardization of tumour banking, collection/storage of patient material .....	29
1.3.3.3	T 3.3: Genetic characterization of involved paediatric leukaemias.....	30
<b>1.3.4</b>	<b>Work package 4: Networking, dissemination and regulatory affairs.....</b>	<b>33</b>
1.3.4.1	T 4.1: Networking with academic community and parent organizations .....	33
1.3.4.2	T 4.2: Networking with regulatory authorities and industry.....	34
1.3.4.3	T 4.3: Awareness creation and public information .....	35
1.3.4.4	T 4.4: Knowledge management .....	37
1.3.4.5	T 4.5: Training of young clinical personnel .....	39
<b>1.3.5</b>	<b>Work package 5: Project management.....</b>	<b>39</b>
1.3.5.1	T 5.1: Administration.....	39
1.3.5.2	T 5.2: Day-to-Day Management.....	40
1.3.5.3	T 5.3: Progress Management .....	40
1.3.5.4	T 5.4: Legal and financial Management .....	41
1.3.5.5	T 5.5: Ethics Management.....	41



<b>1.4 The potential impact (including the socio-economic impact and the wider societal implications of the project so far) and the main dissemination activities and exploitation of results.....</b>	<b>43</b>
1.4.1.1 Improving prognosis of children with ALL in Europe .....	43
1.4.1.1 Standardized diagnostics and risk factors .....	43
1.4.1.2 Best available standard therapy .....	43
1.4.1.3 Development and Integration of new agents .....	43
1.4.1.4 Reduction of toxicity and long term sequelae .....	44
1.4.1.5 Innovative statistical designs .....	44
1.4.1.6 Development for treatment strategies for the whole world .....	44
1.4.1.7 Infrastructure meeting the high-level requirements on GCP, QM, and regulation .....	45
1.4.1.8 GCP conform comprehensive trial database system MARVIN.....	45
1.4.1.9 Reliable partner for industry and regulatory authorities.....	45
1.4.1.10 Networking with academic structures.....	46
1.4.1.11 Comprehensive international tumour bank.....	46
1.4.1.12 Comprehensive translational research programme .....	46
1.4.1.13 Dissemination of knowledge and results at national and international congresses.....	46
1.4.1.14 Publication of results in high-level journals.....	47
1.4.1.15 Selecting and investigating new agents in the best interest of the patients .....	47
1.4.1.16 Integration of parent's knowledge and interests .....	47
<b>1.5 The address of the project public website, if applicable as well as relevant contact details.....</b>	<b>48</b>



## 1.1 EXECUTIVE SUMMARY

Survival of children with acute lymphoblastic leukaemia (ALL) has significantly improved over the past decades. Nevertheless, relapse of the disease remains a leading cause of mortality in childhood cancer. Given the rarity of childhood relapsed ALL, only a large international cooperative group can recruit sufficient patients for prospective studies with specific questions in biological subgroups. Under the umbrella of the International BFM Study Group and with the support of the EU FP7 Program, the relevant mainly European study groups have formed the worldwide largest **International Study for children and adolescents with Relapsed ALL**, IntReALL 2010. The consortium has developed a platform for diagnostics, optimized standard treatment with innovative elements, and translational research for improvement of survival of the affected children and better understanding of this life-threatening disease. To achieve this goal, the consortium has included into the project clinical study groups representing 20 different nations (3 not participating in the FP7 project), 2 academic institutions to create the study database and the statistical framework, and 4 small/medium enterprises with pharmaceutical, biotechnological, information technological and management background. The IntReALL 2010 consortium has set up two clinical trials with the first aim to optimize the standard treatment including chemotherapy and allogeneic stem-cell transplantation, and with the second aim to integrate new innovative and targeted drugs. The consortium formed a trial steering committee, which developed the conception of the trials and wrote the study protocols. To manage the qualification, initiation and maintenance of the involved countries with a total of up to 250 involved treating centres, the group established an extensive trial structure. This includes the set-up of a complex contractual framework and a central trial management structure including regulatory affairs, pharmacovigilance and monitoring at the coordinating international study centre of the sponsor Charité, Berlin and at each of the involved national study centres. This infrastructure ensured a homogeneous agreement on the procedures, compliance with international and national legislation, consideration of ethical aspects, and prospectively monitoring the safety of the involved patients as well as the quality and integrity of the data documented by the treating centres. Furthermore, parent organizations are involved to review the process, the protocols and the consent forms. The web-based clinical database system MARVIN, developed by the involved company XClinical, has been established and optimized for the two trials to allow a GCP (good clinical practice) conform documentation and provide a comprehensive central monitoring tool for the sponsor and the national co-sponsors. The IntReALL Consortium has standardized the relevant diagnostic methods and established an international network of diagnostic reference institutions. Furthermore, the group has established a virtual tumour bank allowing for an integrative search for material for specific cooperative research projects. The involved biotechnological company GenomeScan has performed next generation sequencing analyses of a candidate gene panel established by the consortium to detect alterations relevant for prognosis and suitable for targeted treatment options. Patients have been stratified into two distinct risk groups: A standard (SR) and a high risk (HR) group, defined by established risk factors, time to and site of relapse, and immunophenotype of the disease.

The Consortium prioritized the trial IntReALL SR 2010 for the larger SR patient cohort. The group compares randomly the currently best available treatment protocols ALL-REZ BFM 2002 and ALL R3 and thereby establishes them in all participating countries. Furthermore, the



efficacy and safety of the humanized monoclonal antibody Epratuzumab directed against CD22 manufactured by the involved pharmaceutical company Immunomedics is investigated. The drug is randomly combined with the early consolidation of both standard chemotherapy arms. The trial has been opened for recruitment in May 2014 and has recruited more than 350 patients, which is more than half of the numbers required to answer the study questions. In the course of the trial, several amendments have been realized. The sponsor has submitted regular safety update reports and has held several data safety monitoring committee meetings. No relevant safety issues could be identified so far and the trial can be further conducted without modifications.

For HR patients, the trial IntReALL HR 2010 investigates the potency of the proteasome inhibitor Bortezomib randomly combined with the ALL R3 standard induction chemotherapy to improve remission rates. The trial applies a covariate-adjusted response-adaptive (CARA) randomized statistical design starting with a 2:1 ratio of case and control arm and adapting the ratio depending on the real response as assessed by planned interim analyses. The design allows for flexible adaptations of the trial to integrate eventually new developments in the field. All regulatory approvals have been achieved and the trial can start recruiting patients in the end of 2017. At the end of the HR consolidation, an investigational window has been implemented to allow further studies in this patient cohort. Since November 2015, this window is used for an industry-sponsored trial, randomly comparing the efficacy and safety of a CD3 and CD19 directed bi-specific monoclonal antibody Blinatumomab with the third standard consolidation chemotherapy course HC3.

IntReALL 2010 is embedded in a network of European academic structures relevant for childhood cancer. IntReALL experts are regularly involved in the conception and prioritization of early clinical trials with new drugs in childhood ALL. The IntReALL platform serves as first option to integrate and investigate the most promising new drugs in a curative treatment strategy and warrants drug development in the best interest of the patients.



## 1.2 A SUMMARY DESCRIPTION OF PROJECT CONTEXT AND OBJECTIVES

Acute lymphoblastic leukaemia (ALL) is the most common malignant disease of childhood with an incidence of 4/100.000 children per year in Europe. Over the past 4 decades, survival has improved from less than 20% to over 80%. This is primarily the result of risk stratification and intensification of standard therapy for all categories of patients. As a result, treatment is complex, prolonged and toxic. About 15-20% of patients suffer a relapse of the disease, resulting in an incidence of about 0.7/100.000 children per year in Europe. With the use of intensive combination chemotherapy and hematopoietic stem cell transplantation (HSCT), currently 40-50% of the children with ALL relapse can be cured. Well-defined risk factors allow distinguishing between children with acceptable prognosis after chemotherapy alone and those who can be cured only by additional HSCT. However, substantial parts of patients still relapse after full intensive treatment suggesting that alternative strategies are required. Thus, ALL relapse is one of the most frequent causes of death in childhood malignancies. In the modern era, a number of new drugs are available which could be of benefit for children with ALL. Some of these drugs target specific pathways or molecules, have little or no side effects and carry the promise of decreasing toxicity and improving outcome. Numbers of paediatric patients with relapsed ALL even in the larger member states are too small to perform prospective controlled clinical trials for improving standard therapy and integrating new agents. Therefore, the IntReALL consortium has been founded as a large international collaborative group with the aim to establish a comprehensive platform for diagnostics and treatment of childhood relapsed ALL in Europe and beyond. Experts from the International BFM Study Group (I-BFM SG), a collaborative expert group for childhood leukaemia and lymphoma in Europe and other continents, have taken this initiative.

Main objectives of the IntReALL project were to:

1. implement prospective clinical trials for harmonization and optimization of the best available standard therapy and integration and prospective evaluation of the most interesting new agents
2. implement the infrastructure for a large international trial including GCP conform clinical trial management and a GCP conform web-based study data base
3. establish harmonized diagnostic procedure for relapsed/refractory ALL and a comprehensive harmonized strategy for tissue banking and biological studies to improve knowledge on the disease, discover new risk factors and potential targets for new drugs
4. establish a strong and effective network with other international academic organizations dedicated to paediatric oncology, international regulatory authorities and pharmaceutical industry allowing for optimized development of new agents, and with parent organizations to warrant a strategy in the best interests of the children with ALL
5. involve innovative small and medium sized enterprises (SME's) contributing expertise in diagnostic and therapeutic biotechnology, IT and management to the Consortium
6. improve awareness of the public and of medical professionals on childhood relapsed ALL. Thus, improving recruitment rates for the trial and informing on the effective use of EU budget with direct impact on improvement of the medical care of the European population.



**Figure 0.1: IntReALL Consortium, participating countries and study groups (Japan, Australia and Spain are not partners of the FP7 project)**

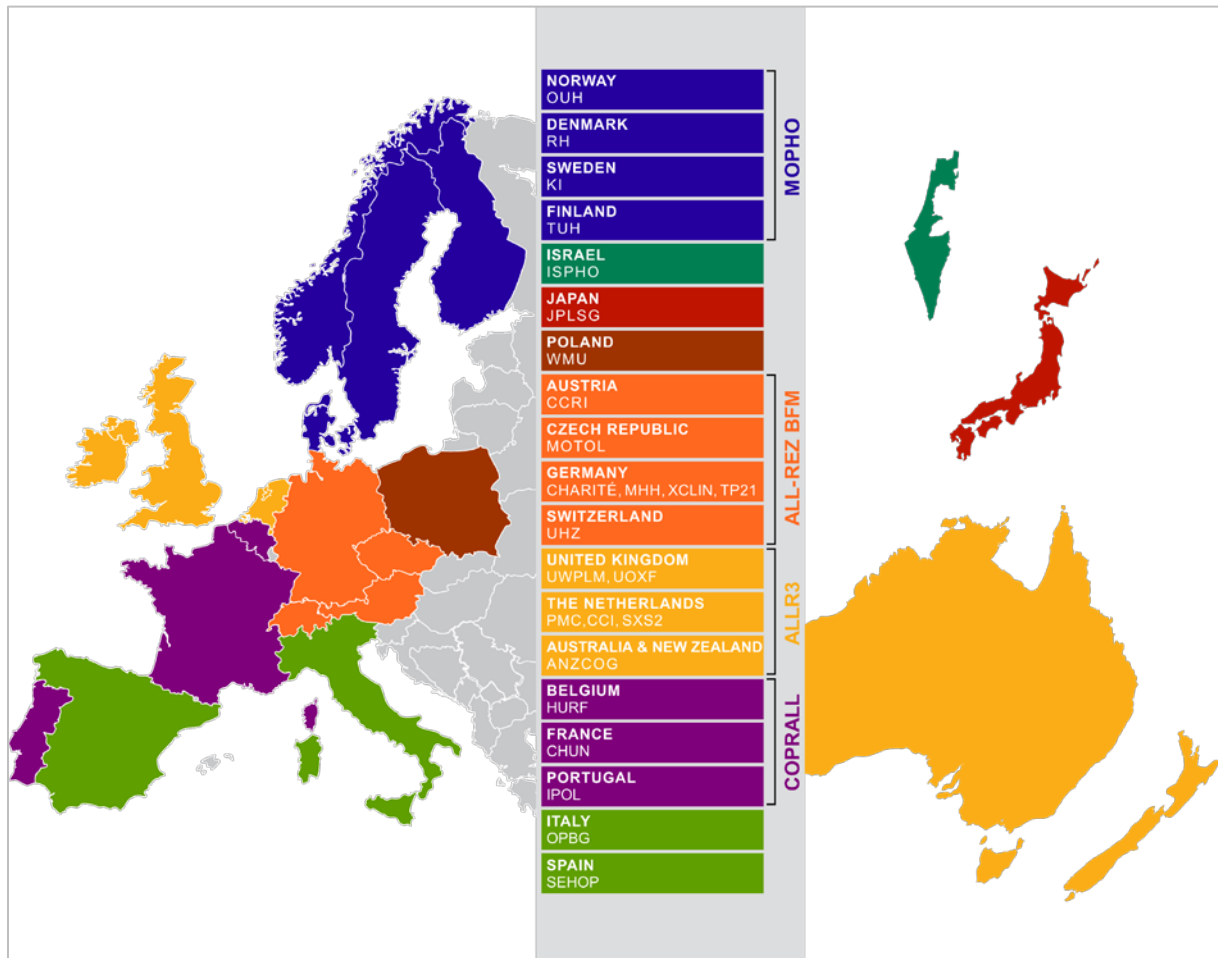

In the first 24 month, the basis for the project has been established within five work packages, clinical trial, database and statistics, diagnostics and biological research, networking, dissemination and regulatory affairs, and project management. Separate trials for standard (SR) and high-risk (HR) childhood relapsed acute lymphoblastic leukaemia (ALL) have been developed. For SR patients, the ALL-REZ BFM 2002 and the ALL R3 regimens are randomly compared to establish the best available standard therapy. Furthermore, as first new and targeted drug, the CD22 directed monoclonal antibody Epratuzumab is randomly investigated during consolidation. The manufacturer Immunomedics, SME partner of the project, warrants production, shipment and labelling.



**Figure 0.2: IntReALL SR 2010 protocol overview**

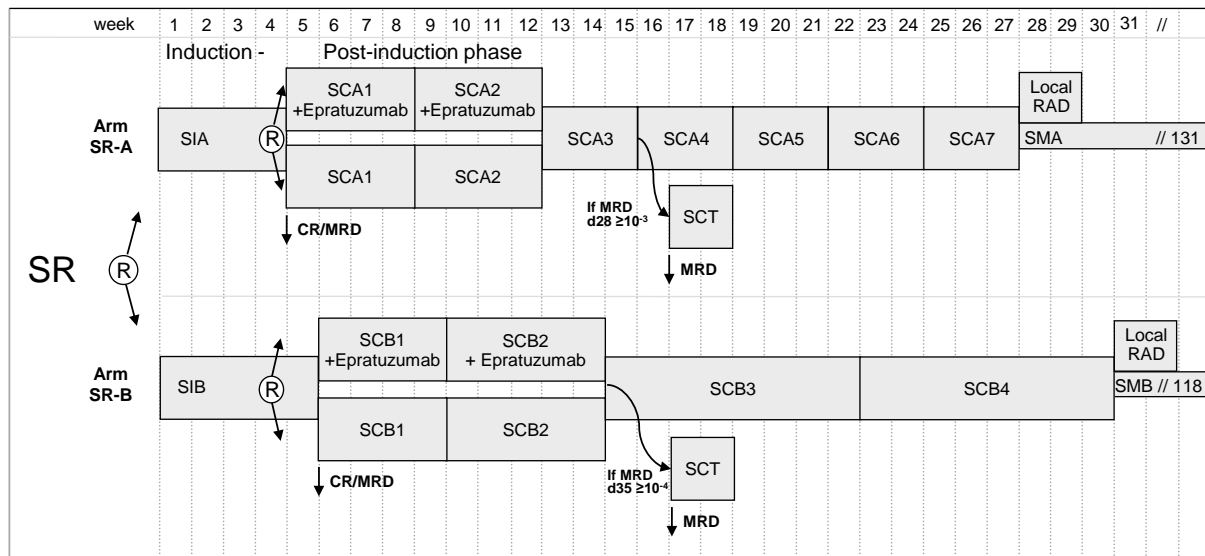

The implementation of the larger SR phase III trial has been prioritized. The trial is approved by all required regulatory and ethical instances and has been opened for recruitment in May 2014. A GCP compatible trial infrastructure has been established at the international sponsor Charité and the national co-sponsors. The department for legal affairs has set up a framework of contracts covering all involved parties. The finalization of the complex sponsor delegation and site contracts integrating the requirements of the involved pharmaceutical company Immunomedics bound to US law and FDA requirements led to delay of the whole procedure and thus the opening of the SR trial. In the meantime, the majority of participating countries have signed the co-sponsor contracts and have been initiated for starting patient recruitment. One-hundred-seventy-seven (70%) of the planned 252 clinical study sites have signed contracts and been opened. Half (347) of the required patients have been recruited so far showing unexpectedly high randomization compliance. A series of five substantial amendments of the IntReALL SR 2010 protocol have been approved by the competent authorities.

The central pharmacovigilance revealed 211 reported serious adverse events so far. The fourth data safety update report (DSUR) has been accepted by the competent authorities.

The Data Safety Monitoring Board (DSMB) has met for the 5<sup>th</sup> time on September 25, 2017 and has approved the further conduct of the trial.

These numbers demonstrate that after solving the demanding organizational, ethical and legal problems there is a high interest in and acceptance of the study among the involved parties and in particular the patients and their families.

A study database for the SR and the HR trials has been set up using the MARVIN system provided by the SME XClinical. The database for the SR trial is finalized and has been opened for study data entry since March 2015. A 1<sup>st</sup> amended study database version considering the IntReALL SR protocol amendments has been launched. For patients not being included into the trial due to clinical or organisational reasons, a registry tool is being implemented on the MARVIN system directing them to open clinical trials and to biological studies. XClinical has improved the MARVIN system and adapted it to the requirements of the project, including a multi-trial feature.





Figure 0.3: Patient visit matrix of the MARVIN database

Recruiting center	Subject Id	Registration IntReALL	SR - Trial admittance	SR - 1st Randomisation	SR - Primary ALL	SR - Relapse diagnostics	SR - Phase 1	SR - 2nd Randomisation	SR - MRD	SR - SAE 001	Σ
Testzentrum	123456	✓	✓	✓	!	!	!	!		!	
Testzentrum	GPOH.00328	!									
Testzentrum	GPOH.00417	✓	✓	✓			✓		✓	Q	
A-Wien, St. Anna Kinderspital, POH	GPOH.00439										
Testzentrum	GPOH.00461	✓	✓								
Testzentrum	GPOH.00462	✓	✓	✓					✓		
Testzentrum	GPOH.00463	✓									
Testzentrum	GPOH.00465	!									
Incomplete entries		2	0	0	1	1	1	1	0	1	7
Open queries		0	0	0	0	0	0	0	0	1	1
Complete entries		1	0	0	0	0	0	0	1	0	2
Signature level 1:		4	4	3	0	0	1	0	0	0	12
Signature level 2:		0	0	0	0	0	0	0	0	0	0
Signature level 3:		0	0	0	0	0	0	0	1	0	1

The design of the HR trial investigating the induction regimen Clo/Cyc/Eto had to be modified due to recently reported preliminary adverse data. The Trial Committee (TC) decided to investigate the proteasome inhibitor Bortezomib instead, which had shown an attractive profile in paediatric relapsed ALL. The statistics team from Oxford (CSM) has developed an innovative covariate-adjusted response-adaptive (CARA) randomised design, allowing for early stop in case of superiority/futility and a flexible randomisation rate based on interim analysis results. The TC and the involved parties have written and agreed on the study protocol. The study has been submitted to and accepted by the authorities via the voluntary harmonized procedure (VHP). Several changes required by national Ethics Committees and a revised Investigational Brochure for Bortezomib required a 1<sup>st</sup> substantial amendment of the HR protocol before starting the trial. Due to delayed national approval of the HR protocol, the VHP had to be stopped and further submission to be performed on a national level. The competent authorities and Ethics Committees in Germany and in most participating countries have approved the protocol. Sponsor delegation and site contracts are circulated and being approved until the end of 2017. An investigational window implemented at the end of consolidation is being used for investigation of the safety and efficacy of the CD3/19 directed bispecific monoclonal antibody Blinatumomab compared to the standard chemotherapy regimen HC3 in a study conducted by the manufacturer Amgen.

All participating countries have established standardized diagnostic procedures, reference laboratories and a virtual tissue bank for patient material. The virtual tissue bank is implemented on the SCOPELAND technology database system, which is already established locally by several participating partners. A comprehensive strategy for biological research has been agreed upon with several projects on pathogenesis of the disease, new risk factors and targets for new drugs. The company ServiceXS renamed to GenomeScan has analysed a comprehensive list of relevant candidate genes in leukaemia samples generated from





IntReALL patients and from patients treated within preceding trials as controls for genetic screening. An improved genetic classification of childhood relapsed ALL has been established.

**Figure 0.4: IntReALL HR 2010 protocol overview, new design randomizing ALL-RE3 backbone (R3Mitox) ± Bortezomib (B), modified BFM HR courses (mHR1-3), optional investigational window, stem-cell transplantation (SCT)**

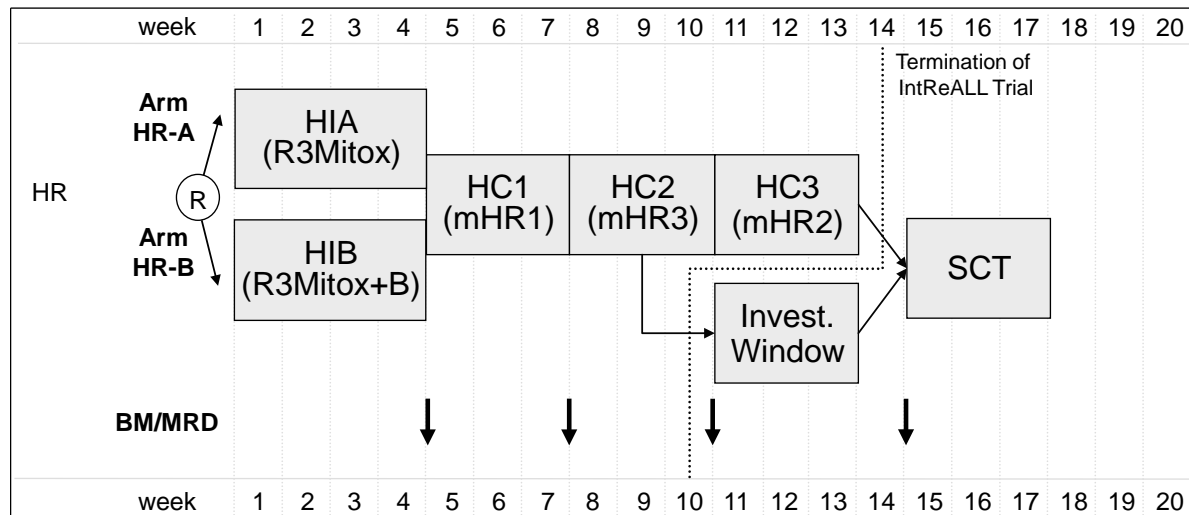

**Figure 0.5: Structure of biological research and flow of research data**

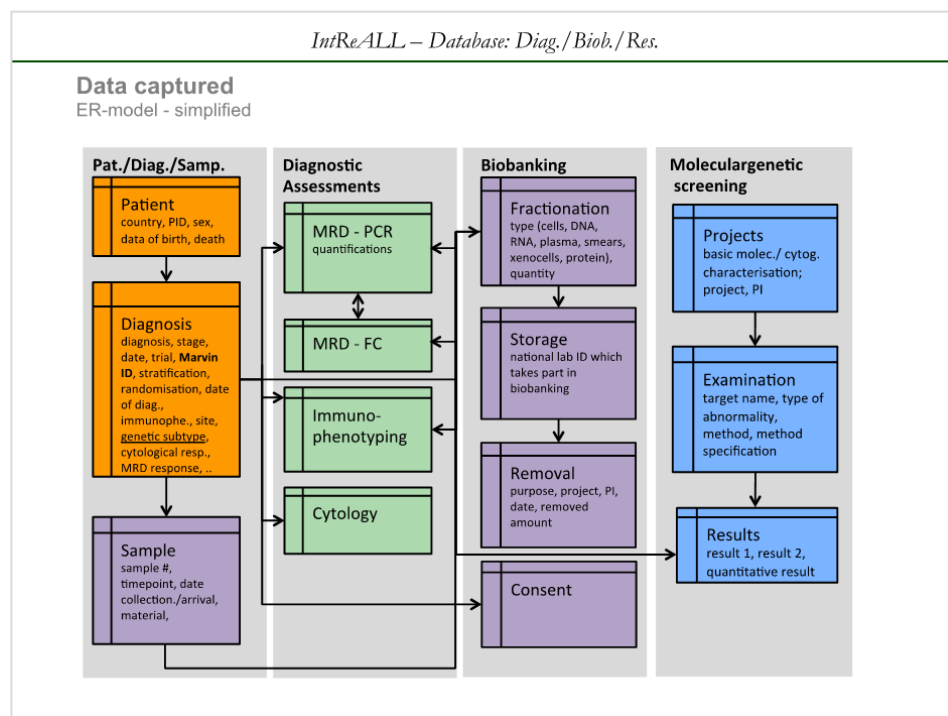

A strong network with other relevant academic institutions involved in paediatric oncology and drug development has been implemented including regular and close interaction with the EMA and industry. The Consortium is directly involved into several drug development activities and has achieved to integrate a decisive phase III trial on Blinatumomab into the treatment strategy for high-risk patients. Several meetings have been held to establish the structure of the



Consortium and to discuss the progress of the project. An Ethical Board has developed a strategy to accompany the project and launched a flyer for patient information. A website and the participation of IntReALL partners in numerous congresses support the awareness on the project in the public and among clinical professionals. A straightforward project management for the project has been established to integrate the specific requirements of an international clinical trial into the framework of a FP7 program.

**Figure 0.6: IntReALL networking structure**

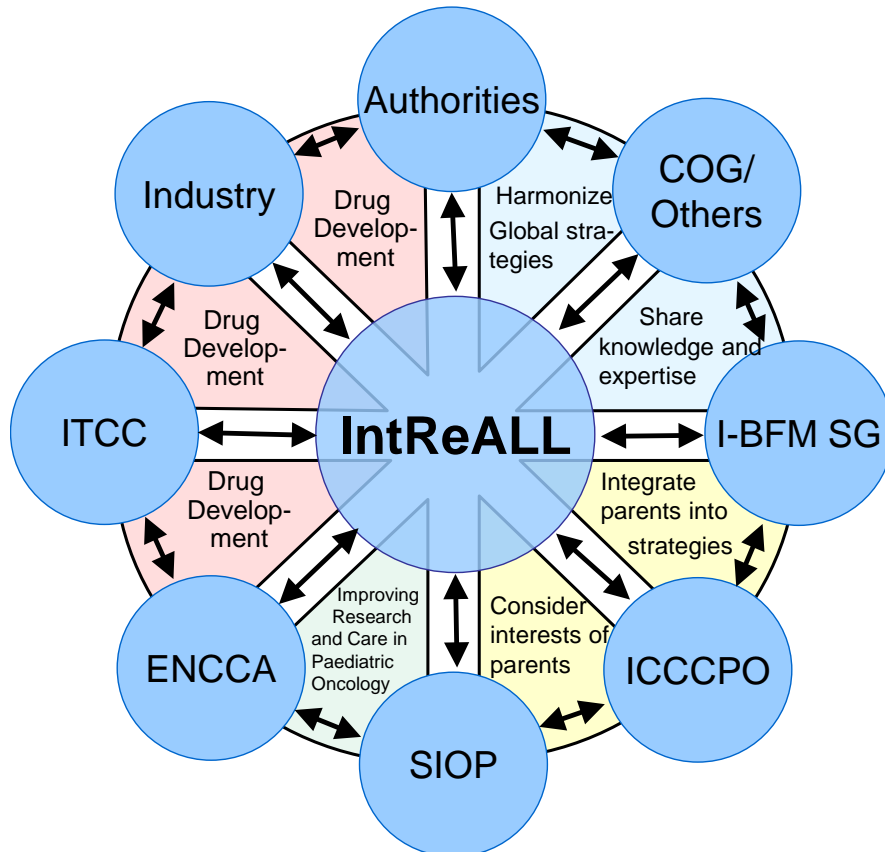

In summary, the IntReALL consortium within the IntReALL FP7 project has established a large international platform for diagnostics, treatment of and research about childhood relapsed ALL. The project has involved 20 mostly European countries participating in the clinical trials (3 of them without participating in the FP7 project), and academic institutions to set up the statistical design, the study database and to perform the analyses. Furthermore, 4 SMEs have been included to provide the investigated drug, the database system, the biotechnological knowledge for comprehensive genetic characterisation of the disease and the management of the whole project. A comprehensive clinical trial infrastructure has been set up addressing the regulatory requirements of approval of the trials by the competent authorities and the Ethics Committees of each involved nation and in case treating centre, of a comprehensive central pharmacovigilance, and of a central and on-site monitoring of the data completeness and quality. The group has established standardized guidelines for diagnostics, an international network of reference diagnostic institutions and a virtual tissue bank allowing for transnational research projects. The experts have defined an increasing set of candidate genes to be



routinely screened in all patients. The MARVIN study database has been programmed for the IntReALL trials and the system has been optimized in close cooperation with the provider XClinical for the specific requirements of complex paediatric multicentre international clinical trials. All users of the database have been trained and provided with individual access to the system. Parent organisations have been involved to review the protocols and the consent forms. An Ethical Board has accompanied the project and identified and discussed critical ethical issues.

Two clinical trials have been established, the IntReALL SR 2010 trial for children with standard risk and the IntReALL HR 2010 trial for children with high-risk relapse of ALL. More than 350 patients have been recruited to the SR trial, the HR trial is being opened soon.

The IntReALL consortium has been involved in the drug development strategies for new agents in childhood ALL in Europe and worldwide. It acts as the relevant expert group for relapsed/refractory ALL in the relevant academic groups and meetings. It has been established as reliable partner for industry and the competent authorities to plan early clinical trials in ALL and in particular to integrate established drugs for the 1<sup>st</sup> time into curative treatment strategies.

The IntReALL consortium has assured the continuation of the work, in particular the GCP conform conduction and termination of the IntReALL SR and HR 2010 trials beyond the FP7 project based on national resources. The established platform is a reliable structure for trials and projects and of benefit for children with relapsed ALL for now and the future.



### 1.3 A DESCRIPTION OF THE MAIN S&T RESULTS/FOREGROUNDS

Acute lymphoblastic leukaemia (ALL) is the most common malignant disease of childhood with an incidence of 4/100.000 children per year in Europe. Over the past decades, survival has improved from less than 20% to over 80%. Nevertheless, about 15-20% of patients suffer a relapse of the disease, resulting in an incidence of about 0.7/100.000 children per year in Europe. Well-defined risk factors allow distinguishing between children with acceptable prognosis after chemotherapy alone, and those who can be cured only by additional Hematopoietic Stem Cell Transplantation (HSCT). In addition to risk factors like time and site of relapse, and the immunological type of the disease, the determination of minimal residual disease (MRD) after induction therapy has led to a clear indication of when to perform a HSCT in children with an intermediate prognosis. With the use of intensive combination chemotherapy and HSCT, currently 40-50% of children with an ALL relapse can be cured. However, substantial parts of patients still relapse after full intensity chemotherapy and HSCT. Hence, ALL relapse is one of the most frequent causes of death in childhood malignancies, and alternative treatment strategies are desperately required.

The main goal of IntReALL 2010 is the improvement of the treatment of childhood relapsed ALL across Europe and selected other countries. Furthermore, the trial intends to investigate the biological and epidemiological aspects of the disease for better understanding of the pathogenesis of ALL relapse. Another aim is to define new and better risk factors allowing for better prediction of outcome and for a precise allocation to the adequate treatment intensity of the individual patient. In addition, the trial has been embedded into the relevant networks in paediatric oncology to improve the interaction between the participating groups, and the dissemination of clinical and scientific findings, and to consider all available expertise. Goals are to get an optimal treatment strategy, to achieve a coordinated drug development within the indication under academic lead and without commercial interests, and to adequately integrate concerns of the patients and their families. Since childhood relapsed ALL is a rare disease, international collaboration is needed to recruit enough patients for studying standard and innovative treatment strategies within this specific patient group. The IntReALL 2010 Consortium includes the collaboration between 20 national study groups including the relevant groups from Europe and selected non-European countries.

Within this cooperative study group, about 300 children with 1<sup>st</sup> relapse of ALL can be recruited per year, making this the largest study for relapsed childhood ALL. This number permits randomized phase III studies in the larger standard risk (SR) group, and randomized phase II studies in the high-risk (HR) group in a reasonable period of 4 and 2 years, respectively.

The overall objectives of the IntReALL 2010 project are the following:

#### Primary objectives

1. Development of a standardized uniform platform of care to improve the outcome of children with relapsed ALL throughout Europe and beyond.
2. Establishing therapeutic strategies for the rapid evaluation of new agents and the efficacy of targeted therapy.
3. Development of an integrative experimental approach to identify and test potential novel pathways for the development of targeted therapy.



4. Establishing a strong integrated network with partnership of industry, academia, parents and regulatory authorities.

### **Secondary objectives**

1. Design and conduct of an international clinical trial in relapsed childhood ALL (IntReALL).
2. Establish the optimum standard therapy for standard risk (SR) patients on a European/ International level by comparing the best available treatment arms of current protocols.
3. Set up the infrastructure for the clinical trial with a framework of contracts and a GCP conform pharmacovigilance and monitoring system.
4. Set up of a GCP conform web based database and a statistical strategy for the trials.
5. Improve the outcome in SR patients without increasing toxicity by the use of targeted therapy with the CD22 directed monoclonal antibody Epratuzumab.
6. Evaluate rapidly the efficacy of new cytoreductive agents in high-risk (HR) patients.
7. Standardize European and International diagnostic and monitoring parameters in childhood relapsed ALL.
8. Standardize national tissue banking initiatives and the development of a harmonized program for related research.
9. Identify novel genomic mutations being characteristic for ALL relapse, prognostic for the outcome and suitable as targets for future treatment strategies.
10. Disseminate results to the scientific community and to public

## **1.3.1 Work package 1: Clinical trial**

The overall objective of WP1 is to develop a platform for clinical trials for children with relapsed acute lymphoblastic leukaemia. The main goal is to provide the best available and further optimized standard treatment of childhood relapsed ALL, and to integrate the most promising new agents with potentially better efficacy and less toxicity into the treatment protocol. To achieve this, a comprehensive infrastructure has been established in all participating countries, allowing for conduction of the clinical trials according to GCP/ICH guidelines and national as well as international legislations in Europe and in selected non-European countries. The work has been performed within 9 tasks.

### **1.3.1.1 T 1.1: Development of two study protocols for SR and HR patients**

#### **1.3.1.1.1 IntReALL SR 2010:**

The protocol for standard risk (SR) patients has been developed by the disease experts of the group, namely the coordinators of the study groups in each countries and involved scientists. Since treatment of patients with SR relapse of ALL had achieved acceptable results with current standard chemotherapy regimen and allogeneic hematopoietic stem-cell transplantation in selected subgroups, the group decided to randomly compare the 2 most established treatment protocols, the ALL-REZ BFM 2002 and the ALL-R3 protocol. As second innovative question, the CD22 directed monoclonal antibody Epratuzumab as major



investigational medicinal product (IMP), provided by the company Immunomedics as partner of the FP7 consortium, is randomly combined with the early consolidation treatment of each arm. The final protocol had been circulated by the CHARITE as the international coordinator of the trial to the trial committee (TC) and has been approved by all members. Furthermore, it has been approved by the involved statistical institution, the manufacturer of the IMP Immunomedics and by parent representatives. The trial has been opened for recruitment since May 2014 (ClinicalTrials.gov identifier: NCT01802814). Since then a total of 5 substantial amendments addressing adaptations, corrections and new information concerning the IMP have been released and approved.

**Figure 1.1 Treatment schedule IntReALL SR 2010**

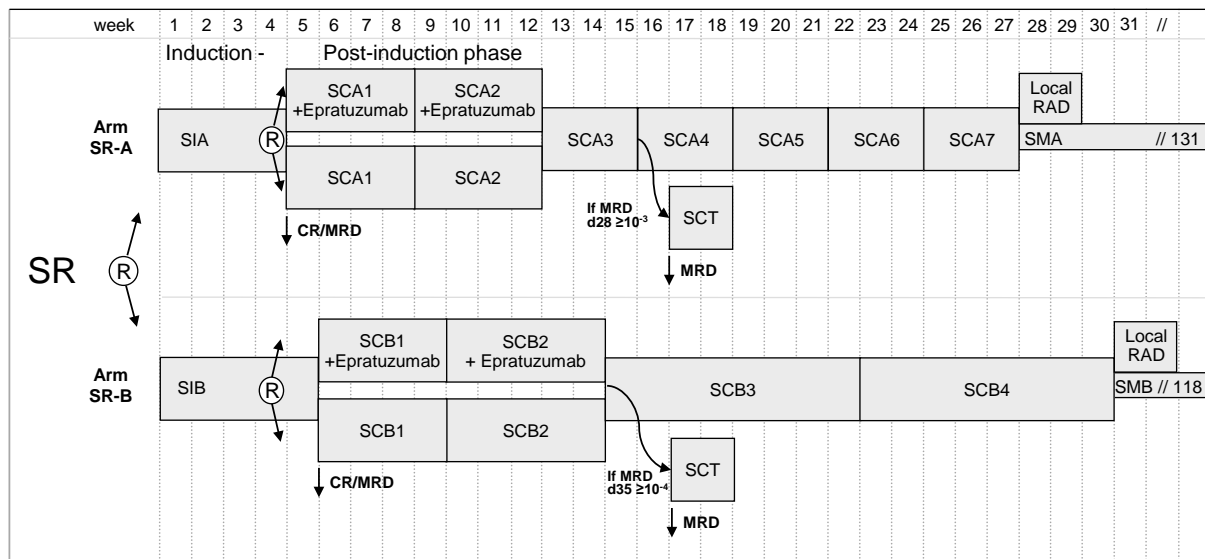

### 1.3.1.1.2 IntReALL HR 2010:

The IntReALL group aimed initially at comparing a new drug combination regimen with clofarabine, cyclophosphamide and etoposide with the established ALL-REZ BFM regimen F1 and F2 for induction therapy of children with high risk (HR) relapse of ALL. A pilot study of the UK group started in 2010 to confirm the feasibility of the regimen in the intended indication, however, revealed inferior event-free survival (EFS) rates compared to historical controls. Therefore, the trial committee decided to change the design using the ALL R3 mitoxantrone regimen as induction backbone, followed by 3 modified BFM HR courses. All HR patients are eligible for allogeneic hematopoietic stem-cell transplantation after achievement of a complete second remission. Since remission rates of HR patients are poor, the HR study focuses on improvement of the CR rates by randomising the addition of the proteasome inhibitor Bortezomib to the backbone, which was developed and licensed for multiple myeloma. Bortezomib has been investigated in childhood relapsed ALL by the COG/TACL group in phase I/II trials in combination with corticoids, vinca alkaloids, anthracyclines and asparaginase. It has shown sufficient feasibility, tolerability and efficacy by improving CR rates compared to historical controls<sup>1</sup>.

<sup>1</sup> Messinger YH, Gaynon PS, Spoto R, et al. Bortezomib with chemotherapy is highly active in advanced B-precursor acute lymphoblastic leukemia: Therapeutic Advances in Childhood Leukemia & Lymphoma (TACL) Study. *Blood*. 2012;120(2):285-290





The updated IntReALL HR 2010 protocol using an innovative CARA statistical design has been approved by the trial committee members, the statistics team Oxford and by the parent representatives. The protocol has been submitted to the VHP procedure in December 2015 and has been approved in January 2016 (Eudra-CT Number: 2012-000810-12). In the further process of the approval, the VHP coordinator has stopped and withdrawn the harmonized procedure due to deviation from the formal process by several involved countries. All further regulatory steps concerning the HR trial need to be realized on the national level. Several Ethics Committees (in particular Germany and Austria) requested substantial changes in the protocol mainly with respect to the statistical design. Furthermore, in summer 2016, a new investigators' brochure (IB) on Bortezomib has been launched by the manufacturer. Both facts required a 1<sup>st</sup> substantial amendment of the HR protocol before the start of the trial. The Consortium decided furthermore to perform the trial with marketed Bortezomib without study specific labelling covering the additional costs from national resources.

The trial with its first amendment has been approved by the German competent authority BfArM and the Ethics Committee of Berlin as well as by most of the authorities of the participation countries. Opening of the trial first in Germany in December 2017 and subsequently in other countries is expected such that first patients may still be recruited in 2017. The total duration of the trial is planned as 3 years until the end of 2020.

**Figure 1.2: Treatment schedule IntReALL HR 2010**

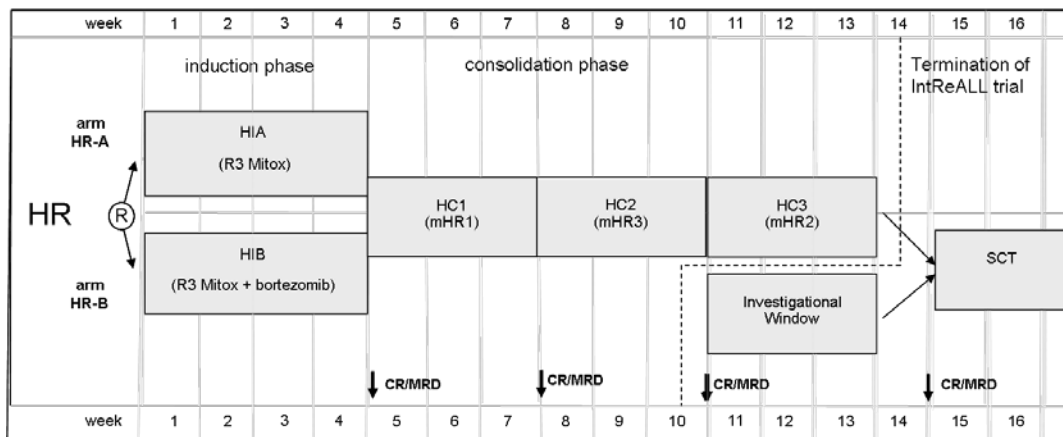

**Figure 1.3: Induction therapy with Bortezomib**

Agent	Dosage	Application	Week 1	Week 2	Week 3	Week 4
Dexamethasone	20 mg/m <sup>2</sup> /d	PO	1-7		1-7	
Vincristine*	1.5 mg/m <sup>2</sup>	IV	1	1	1	1
Mitoxantrone	10 mg/m <sup>2</sup>	IV 1 h	1, 2			
PEG-Asp.**	1,000 U/m <sup>2</sup>	IV 6 h			4	
Methotrexate***	age dep.	IT	1	(1)		
±Bortezomib	1.3 mg/m <sup>2</sup>	IV	1, 4		1, 4	
		Day	1 2 3 4 5 6 7	1 2 3 4 5 6 7	1 2 3 4 5 6 7	1 2 3 4 5 6 7



### 1.3.1.1.3 Investigational window for IntReALL HR 2010

The third consolidation course of the HR protocol has been defined as an optional element. Patients may be subjected to an investigational window allowing for investigation of a new drug at the end of HR consolidation. As first study using this window, a randomized phase III trial on the use of Blinatumomab with the primary endpoint event-free survival has been realized. Blinatumomab is a bispecific T-cell engaging (BITE®) monoclonal antibody directed against CD3 and 19, manufactured by the company Amgen. The drug has shown activity with high CR rates and mostly MRD negative remissions and a favourable safety profile in adult patients with relapsed/refractory ALL<sup>2</sup>. A paediatric phase I/II study had been performed in children with relapsed/refractory ALL in close cooperation with the IntReALL consortium (WP4) and with recruitment of the majority of the patients from IntReALL groups. An attractive activity of the drug with a remission rate of around 40%, induction of MRD negative remissions and a favourable safety profile could be demonstrated<sup>3</sup>. A 4-week course of continuous infusion of Blinatumomab (Blincyto®) is randomly compared to the last consolidation course of the IntReALL HR trial (HC3) within the investigational window (EudraCT number 2014-002476-92). The study is sponsored by Amgen and is a decisive step of the licencing procedure in Europe for paediatric indications (Phase three Trial of Blinatumomab vs Standard Chemotherapy in paediatric Subjects with HR First Relapse B-precursor ALL, ClinicalTrials.gov Identifier: NCT02393859). For patients included into the Blinatumomab window (only B-cell precursor ALL), the investigator driven IntReALL HR trial ends after the second consolidation course (HC2) and patients directly enter the Amgen sponsored part. Afterwards, they receive an allogeneic HSCT, which will be done within the ALL SCTped 2012 FORUM trial (ClinicalTrials.gov Identifier: NCT01949129) in most participating countries. The study has been opened in November 10, 2015.

**Figure 1.4: IntReALL HR 2010, investigational window Blinatumomab vs HC3, HSCT trial FORUM**

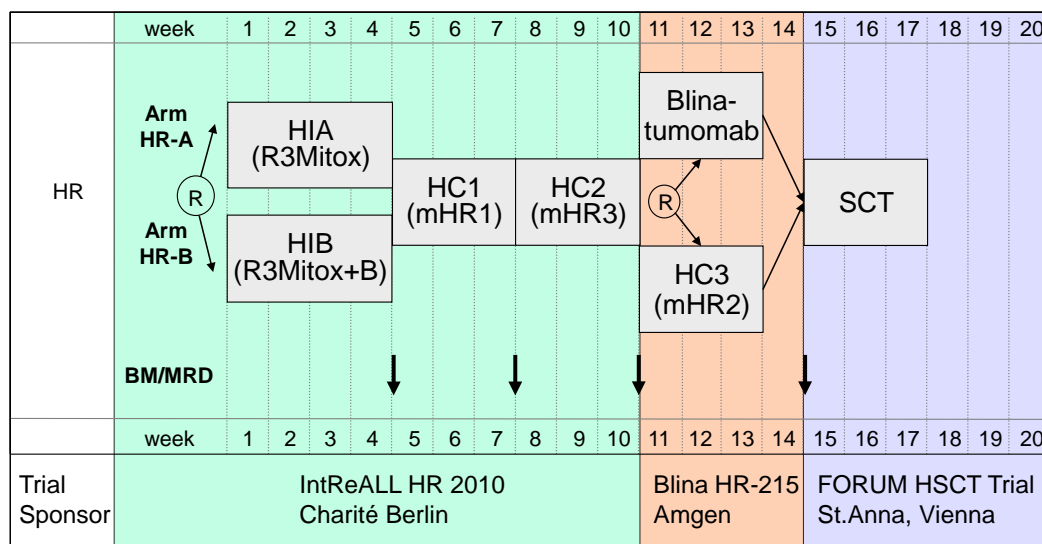

<sup>2</sup> Topp MS, Gokbuget N, Stein AS, et al. Safety and activity of blinatumomab for adult patients with relapsed or refractory B-precursor acute lymphoblastic leukaemia: a multicentre, single-arm, phase 2 study. *Lancet Oncol.* 2015;16(1):57-66

<sup>3</sup> von Stackelberg A, Locatelli F, Zugmaier G, Handgretinger R, Trippett TM, Rizzari C, et al. Phase I/Phase II Study of Blinatumomab in Pediatric Patients With Relapsed/Refractory Acute Lymphoblastic Leukemia. *J Clin Oncol.* 2016 Dec 20;34(36):4381-9

### 1.3.1.2 T 1.2: Set up contract agreements between participating parties

The development of the contractual framework between the sponsor and the involved parties (co-sponsors, manufacturer and scientific institutions) for the SR trial required adaptations and external review from an independent expert institution before being released as final templates. These were an adapted contract with the manufacturer Immunomedics, a modified co-sponsor contract template ready for national adaptations and a site delegation contract delegating all legal requirements of the international sponsor to the participating national sites. This template was again adapted to national requirements and national law (Fig 1.5). The co-sponsor contracts are set up based on German law as long as international issues are concerned, which frequently caused problems in achieving a contractual agreement.

For the HR trial, contract templates for co-sponsors and sites have been adapted excluding the industry related issues. Sponsor delegation contracts have been distributed to all co-sponsors and are currently under review. They contain all changes and adaptations required by the national partners for the SR contracts. A site contract template for the HR trial has been distributed and is adapted to national requirements by the co-sponsors. In addition, the site contracts are based largely on the agreed and signed SR contracts and will not need additional negotiations.

**Figure 1.5: Contractual framework of the IntReALL SR 2010 trial involving external law firm**

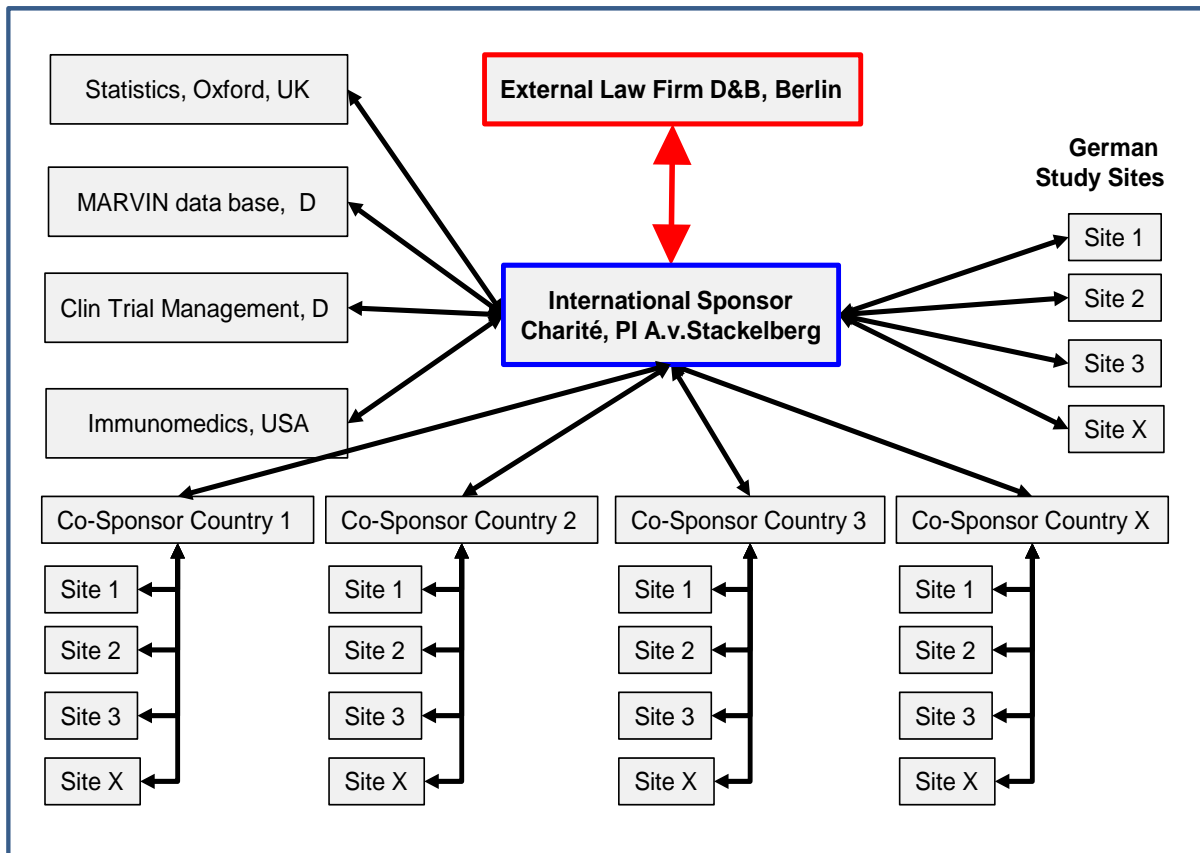



#### **1.3.1.3 T 1.3: Set up and conduct systematic monitoring/source data verification**

The systematic monitoring has been set up in all participating and active countries. Experienced monitoring staff has been recruited for onsite monitoring on a national level. The items to be monitored in the basic data monitoring process are exactly defined in the monitoring manual and reflected in the MARVIN database. Onsite monitoring consists of one monitoring day per patient. The monitoring process is supervised by the national co-sponsors as well as by the international coordinating sponsor. It provides a standardized system and procedure in every participating country.

In addition to the onsite monitoring, central monitoring is performed in the MARVIN database proving completeness and plausibility of the documented data. Via the query function provided by the MARVIN system, issues can be clarified and corrected.

#### **1.3.1.4 T 1.4: Production, labelling and delivery of Epratuzumab**

The manufacturer and project partner Immunomedics warrants the production of Epratuzumab. The production process and quality control is described in the investigator medicinal product dossier (IMPD) and has been approved by the competent authorities. The IMPD is regularly updated. The labelling and delivery of Epratuzumab has been set up and specified for all European and non-European partners. Master-labels have been developed in English for all involved countries as well as labels in the respective national languages. Production is being performed in the USA; the drug is shipped to the local sites via Immunomedics' local branch in Rödermark, Germany, where Epratuzumab is labelled in local languages before shipment.

In summer 2016, the availability of Epratuzumab was interrupted due to regulatory issues. The IMPD had been adapted in 2015, and lots produced according to the new IMPD had been released since June 2016. Since the new IMPD had not been formally approved by the regulatory authorities via VHP until then, the provision of the drug was set on hold until approval of the updated IMPD on July 20, 2016 within a 1<sup>st</sup> substantial amendment of the IntReALL SR 2010 protocol and after national confirmation of the VHP vote. This process led to a gap of patient recruitment to the second randomisation of the SR trial in the summer and early autumn 2016. Since then, the availability of Epratuzumab has not been impaired.



**Figure 1.6: Epratuzumab vials and packages with the multilingual labels developed for the IntReALL SR 2010 trial. The label can be opened and displays as a booklet the information in all involved languages.**

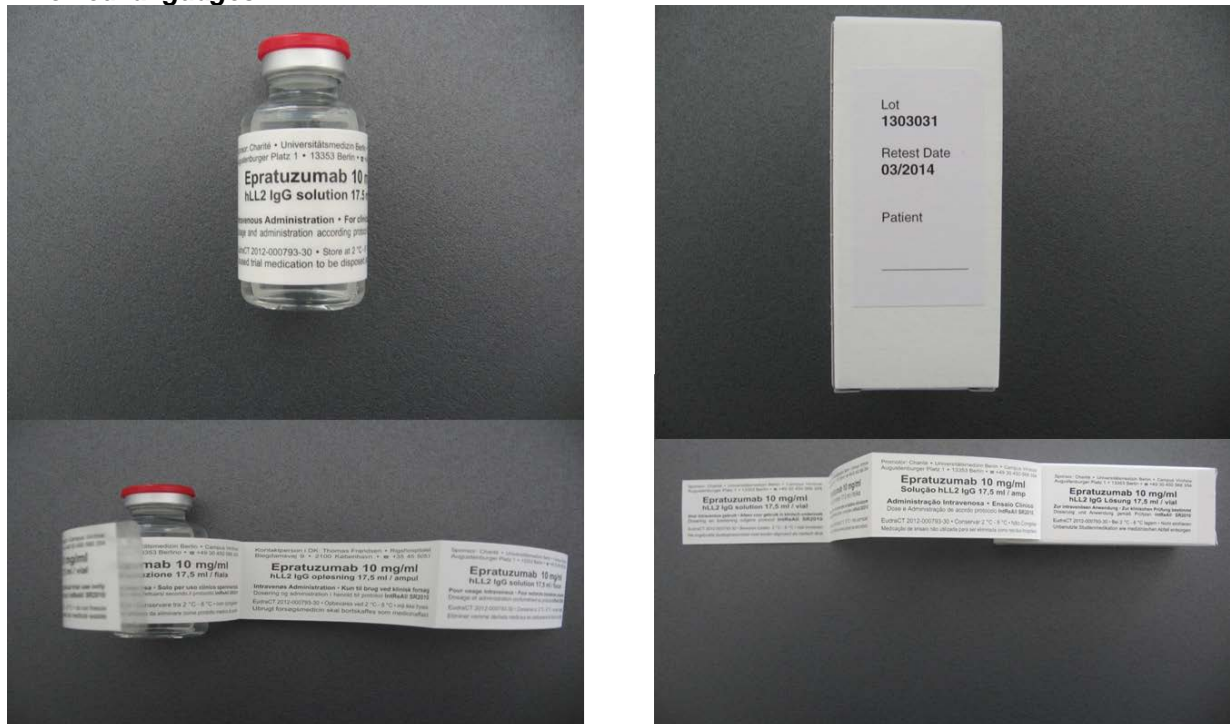

### 1.3.1.5 T 1.5: Centre recruitment

The national co-sponsors have performed systematic checks of qualification of participating clinical sites and feasibility of the trial at the sites. Furthermore, they have checked the qualification of the involved principle investigators. Centres fulfilling all requirements of participation have been approved by national authorities and Ethics Committees. The national co-sponsors set up regular investigator meetings in the participating countries and warrant the updated information of the involved staff on the trial.

In countries open and initiated for the IntReALL SR 2010 trial, site contracts between the co-sponsor and the participating centres are agreed upon and signed. Participating centres are initiated by the national co-sponsor within an initiation visit or a telephone conference guiding the local staff through a power point presentation corresponding to the set used for the co-sponsor initiation. Since initiation of the first centre (Charité Berlin, February 2014) a total of 177 sites (70%) out of planned 252 have been initiated for the SR trial.

### 1.3.1.6 T 1.6: Scientific advice, consultation and submission to regulatory authorities

The IntReALL SR 2010 protocol has been submitted to the leading authority Paul-Ehrlich-Institute (PEI) in Germany via the Voluntary Harmonization Procedure (VHP). Grounds of non-acceptance (GNA) by PEI have been sufficiently answered in the beginning of November 2012, and in the end of November 2012, the trial has been approved. Submission to regulatory authorities and Ethics Committees on a national level followed. The study has been approved by all involved countries except Poland.



The approval process of the IntReALL HR 2010 was considerably delayed due to several reasons including the complete change of the treatment and study design. The final protocol has been submitted via VHP in December 2015 and has been approved in January 2016. Both trials required substantial amendments submitted to the competent authorities via VHP due to changes of the IB's, the investigational medicinal products dossier (IMPD's, Epratuzumab for SR, Bortezomib for HR), due to requirements of involved Ethics Committees and due to changes/adaptions of the protocols in the course of the trials. Recently, the VHP coordinator has closed the VHP process for the HR trial due to delayed national confirmation in some partner countries. Further process is performed on a national basis only.

#### **1.3.1.7 T 1.7: Recruitment and documentation of SR and HR patients**

Recruitment of patients into the SR trial has been started in May 2014. Patients can only be recruited in countries and sites initiated for the trial. Since not all intended sites have been initiated (currently 70% initiated), recruitment accordingly lies below the expected 200 patients per year after opening of all countries ( $n = 20$ ) and sites ( $n = 252$ ). Taking this into account, the statistical model for the trial assumes a recruitment of 100 patients per year on average in the first 2 years and 200 patients per year afterwards. A total of 612 patients (306 per arm of the 1<sup>st</sup> randomisation) are needed to address the primary endpoint of the first randomisation and 456 are required for the second randomisation. In August 2017, 52% of required patients have been recruited for the 1<sup>st</sup> and 51% for the 2<sup>nd</sup> randomisation. The randomisation compliance for both randomisations is unexpectedly high with only 9% of eligible patients rejecting the 1<sup>st</sup> and only 12% rejecting the 2<sup>nd</sup> randomisation. The goal to recruit about 200 patients per year starting with the 3<sup>rd</sup> year of recruitment has not yet been achieved (Fig. 1.7a). Recruitment rates are intended to improve by opening more centres in UK as well as opening the countries Poland, Spain and Sweden. Furthermore, a decrease of recruitment for the 2<sup>nd</sup> randomisation since June 2016 due to the interrupted availability of Epratuzumab in summer 2016 (see also T1.4) which has been resolved in all countries until January 2017 lead to an increase of the recruitment rate back to the rates before the interruption (Fig. 1.7b). Catching up with the recruitment rate and depending on the randomisation compliance, a total duration of recruitment of 5 - maximum 6 years is expected with a closure of recruitment presumably in the summer, the latest at the end of 2019.

The HR trial has not been opened for recruitment due to a delayed finalization of the design and the contractual and regulatory process. We expect an opening and start of patient recruitment in December 2017.



Figure 1.7: a) cumulative recruitment for the 1<sup>st</sup> and b) the 2<sup>nd</sup> randomisation (status 03.08.2017)

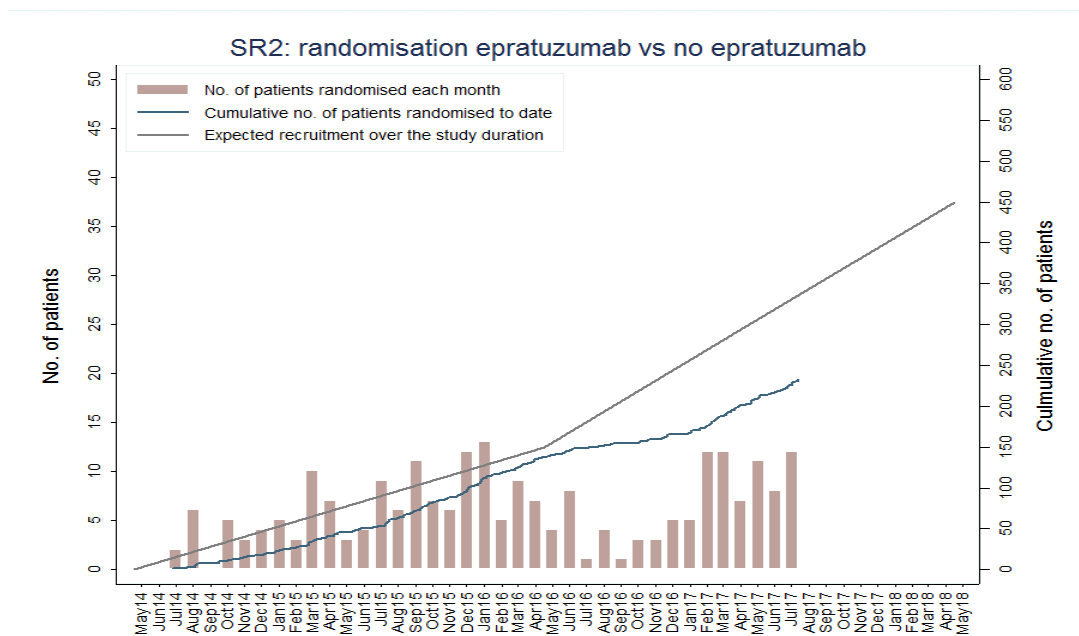
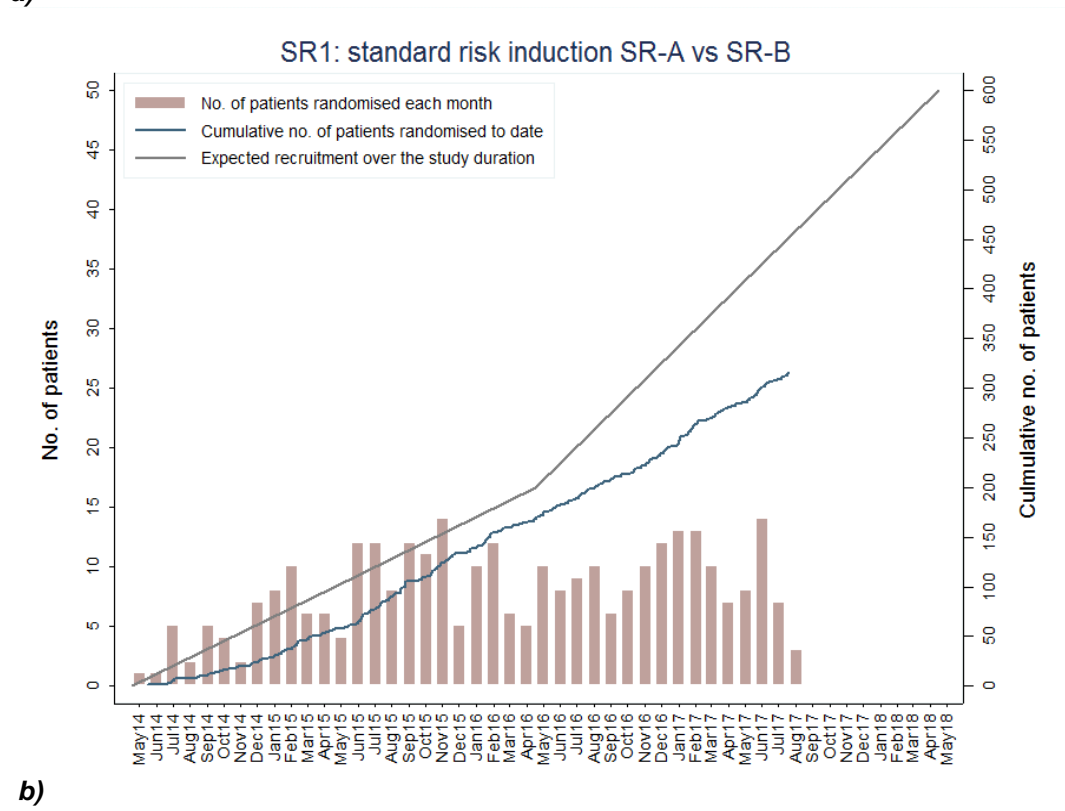



#### **1.3.1.8 T 1.8: Set up and realization of central pharmacovigilance, safety reports**

A central pharmacovigilance system has been set up at the sponsor's site as described in a pharmacovigilance manual. The protocol and the manual provide definitions of (serious) adverse events ((S)AE) as well as suspected unexpected serious adverse reactions (SUSAR), and describe assessment and management (reporting, documentation, and time-lines for reporting) after occurrence of such events as well as exceptions of SAEs.

Since start of recruitment of patients for the SR trial in May 2015, pharmacovigilance has been prospectively applied as defined in the protocol. Serious adverse events as defined in the protocol need to be reported within 24 hours after the PI becomes aware of them using the initial SAE report form by fax to the central pharmacovigilance. Regular follow up reports are submitted by the treating centre and centrally assessed until the SAE has resolved.

#### **1.3.1.9 T 1.9: Pharmacokinetic and -dynamic monitoring of Epratuzumab**

In consultation with Immunomedics, 10 centres each in Great Britain and Germany have been selected to collect 20 serum samples in arm A and 20 in arm B for pharmacokinetic (PK) measurements of Epratuzumab to put the extra efforts at some larger hospitals. All the samples will be sent to Immunomedics, USA, for measurement. All costs related to collection of samples and shipment are covered by the company. The process of sampling, storage and shipment as agreed upon with Immunomedics is described in detail in a working procedure provided by the sponsor.

A report on available PK data will not be available until the end of the project in month 72, since Immunomedics will measure the data in one-step after receiving all patient samples.

Samples for pharmacodynamic (PD) monitoring are collected and analysed at the local sites. The analysis includes lymphocyte subpopulations (B-, T- and NK cells) and immunoglobulin levels at defined time-points. A secondary toxicity endpoint is the B-cell depletion and resulting immunoglobulin deficit of the Epratuzumab arm compared to the arm without Epratuzumab. The comparative result will be disclosed only after the end of the trial in the final analysis.

### **1.3.2 Work package 2: Database and statistics**

The objective of WP2 is to establish an internet based trial database and a statistical model for the IntReALL SR and HR 2010 trials.

#### **1.3.2.1 T 2.1: Planning and programming of the IntReALL SR and HR study database**

Originally, one internationally accessible database for the IntReALL trial was planned. For this purpose, the Central Data Management (CDM)-GPOH/MHH group, experienced in the setup of databases for national and international trials, was assigned to establish that database in close collaboration with the study co-chairs at the Charité Berlin and the University of Manchester. Due to the separation of the planned IntReALL protocol into two protocols, two independent databases were necessary, one for the SR patients and one for the HR patients. A data dictionary for the SR protocol has been finalized using the Study Composer provided by XClinical. Based on this, the MHH group developed the database for the IntReALL SR 2010 trial on the MARVIN database system. This system is provided by XClinical and is an integrated



part of many other trials including several studies and registries of the GPOH (more than 20 mostly international currently open, managed by the MHH group).

The development of the databases has been divided into three steps and completed accordingly:

1. Definition of the data structure
2. Implementation of the data structure, the workflow and the logic in MARVIN
3. Test and validation of the system according to GCP standards.

After programming of the SR MARVIN database, an extensive validation process has been realized. The database has been tested by a defined group of users, including documentary staff, monitoring staff, the international principle investigator at the coordination study centre Charité Berlin and at the national study centre of the UK, Manchester. Test patients with different features and different outcomes have been fully documented; any problems and mistakes have been reported to the MHH group. The database has been corrected, adapted, and re-evaluated. The biological database has been implemented by the central laboratory of the German study group based on the SCOPELAND technology system. The SCOPELAND database has been designed as a virtual international tissue bank covering the national tissue banks with respective interface options.

The database for the HR trial has been set up based on the SR study experience. Starting the development of the database for the HR trial was delayed because of a delayed development of a final protocol. The protocol was finalized in December 2015. A list of required data fields for the HR trial has been developed. More than 350 patients are documented in the database for the SR study. A SAS program for the conversion to SAS analysis files has been written by the Centre for Statistics in Medicine, Oxford (UOXF), UK. Data have been exported from Marvin in CDISC-ODM format and used for several interim reports to the DSMC.

#### **1.3.2.2 T 2.2: Set up of a statistical model and analysis plan for the IntReALL SR and HR trial**

The partner institution Centre for Statistics in Medicine, Oxford, has developed statistical models for the IntReALL 2010 trials. For the SR trial, 2 subsequent randomizations have been implemented with the probability of the endpoint EFS. For the HR trial, an innovative model using an adaptive design for phase II randomization to ensure all centres can accrue is required. The covariate-adjusted response-adaptive (CARA) randomised design starts with a 2:1 randomization rate allocating randomly more patient into the better arm as soon as a difference becomes aware in planned interim analyses. Patient numbers and the power were calculated taking into account the available patient cohort. A completion of recruitment of SR patients within 4 years and recruitment of HR patients within 3 years is intended. The statistical models for the SR trial and the HR trial were developed in close collaboration with the international study centre Charité Berlin and the national study centre in Manchester. Analysis plans for SR and HR were composed describing the statistical models, the stopping rules and the intended interim and final analyses.

#### **1.3.2.3 T 2.3: Instruction courses and follow-up hosting of Marvin database**

The first instruction courses for using the MARVIN database for IntReALL trials for the staff of participating partners have been conducted in November 2013 by the support team of the MHH group. This trained staff then trained personnel at its own site and the other national sites in



instruction courses following the guidelines of the MHH using Power Point slides provided by the MHH group. Organization and logistics have been supported by the international study centre. In the first months of 2015 the study centre in cooperation with the CDM did online trainings for data entry personal and investigators of sites who already had or were about to start recruitment. The adaptation of the existing training manuals to the requirements of the IntReALL SR 2010 trial has been completed; the CDM-Marvin handbook has been adapted to the multi-trial version of MARVIN. For the HR trial, some trial specific adaptations need to be trained. Most importantly, the IntReALL centres are initiated for MARVIN, staff is trained, has individual log-ins with defined roles and has gained experience using the database.

### 1.3.2.4 T 2.4: Optimization of the MARVIN system for international paediatric oncology trials

In October 2012, the first version of MARVIN 2.5 has been released providing the basis for the implementation of new features in MARVIN. The productive version of the CDM-MARVIN-System started in 02/2014. The database has been further developed with different updates, and the last version 2.6.3 has been released on October 4, 2017.

For the collaboration between different studies and for combining data from biobanks and studies, it is necessary to use pseudonyms. Pseudonymisation is encouraged by the EU General Data Protection Regulation. A pseudonymisation service has been integrated in MARVIN, so that a pseudonym can be generated when a new patient is registered in MARVIN. Basis is the European Unified Patient IDentity Management (EUPID) developed in the course of the EU project ENCCA (European network for cancer research in children and adolescents).

**Figure 2.1: The screenshot shows the integration of the EUPID with MARVIN**

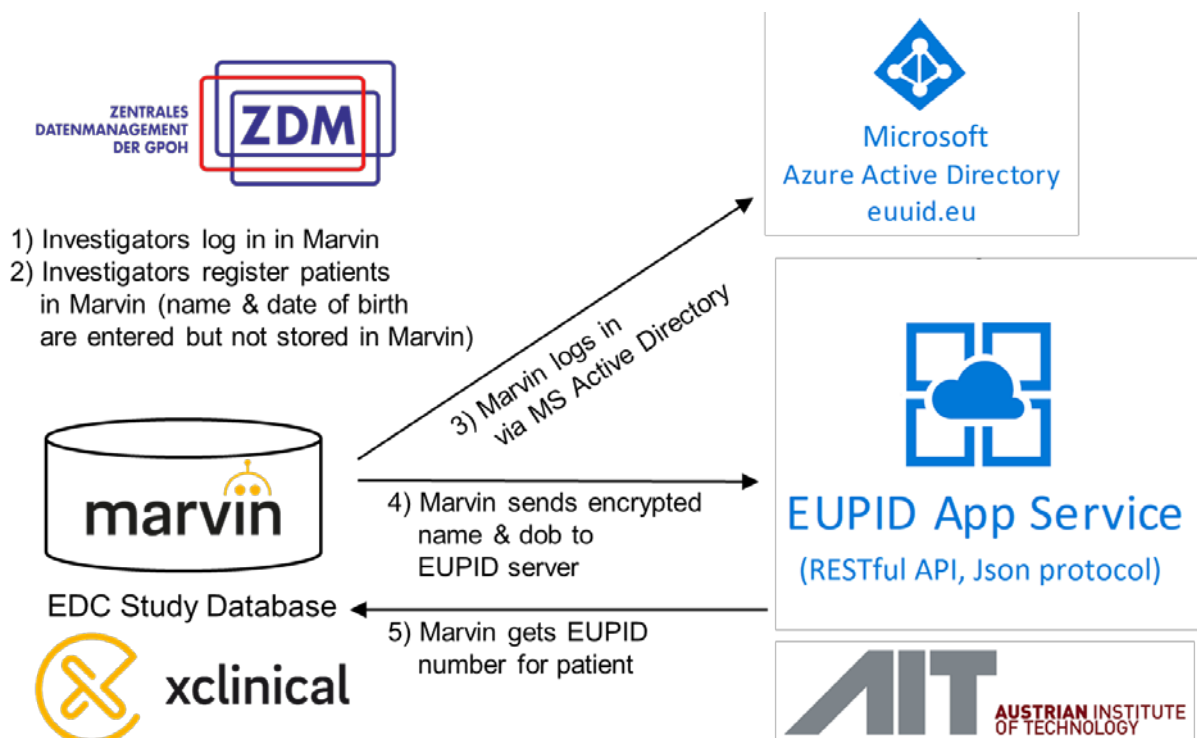

2017



#### **1.3.2.4.1 T2.4, 1) Expanding of multitrial capabilities:**

MHH and XClinical (XCLIN) have cooperated to specify, develop and test new features and to improve existing features of the MARVIN study software. The centralized registry database has been integrated in the new MARVIN multi-trial environment such that patients can be centrally screened and that data can be electronically and automatically be transferred to different clinical study databases (which may be added at any time). Furthermore, the MARVIN multi-trial system allows to share data, e.g. between a registry and a clinical trial or between two clinical trials, when patients are recruited for both the registry and one trial or the two trials. Features for sharing of data between two or more studies / registries have been specified. The specification includes two different mechanisms that can be used to transfer patient data (automatically and on request / manually). An automatic data transfer has been implemented, so that it is possible (e.g. if a certain condition evaluates “true”) to share clinical data between different MARVIN instances given that the sending and the receiving MARVIN instance contain the same metadata.

A mapping mechanism was implemented, which allows the transfer of data between different MARVIN instances, even when the sending and receiving instances have different metadata (i.e. different CRF structures).

#### **1.3.2.4.2 T2.4, 2) Patient selection for future / follow-up studies:**

A prototype of the central MARVIN instance (“Screening instance”) has been set up, which is used to register patients for all trials, which runs under the auspices of the GPOH. The centralized registry database for all patients has been deployed on MARVIN version 2.5 and made available in a so-called MARVIN multi-trial group environment. Patient data from the registry can be electronically sent to multiple clinical trials after screening. Initially several studies used the same physical instance which complicated the setup and maintenance, but spared server costs. All studies have been split, so that each study uses its own server. This will also enable easier implementation of study amendments in the future.

During the course of the project, the Consortium decided to improve the documentation of IntReALL patients by implementing an IntReALL registry as 1<sup>st</sup> entry portal. The registry allows pseudonymisation and tissue banking before allocating the patient further into open trials such as the IntReALL SR / HR trial, the Blinatumomab randomized trial for HR patients or any open phase I/II trial in case of respective eligibility.

#### **1.3.2.4.3 T2.4, 3) More complex user and site management:**

A set of features for MARVIN version 2.5 has been implemented which includes the opportunity that several studies (e.g. a registry and a clinical study) use the same patients’ data in the same user and site database. This feature reduces the workload for administrative tasks significantly. Additionally, enhancements of the MARVIN communications module (“Messaging”) have been implemented which can now limit the list of users that are visible, e.g. to only show the users within the same site or country.

#### **1.3.2.4.4 T2.4, 4) Two Phase randomization:**

The two-phase randomization has been implemented using existing features of the MARVIN system in innovative ways to address the requirements of the SR trial.

For the HR trial, the covariate-adjusted response-adaptive (CARA) randomisation algorithm was implemented in MARVIN as required for the specific statistical design. The CARA-factor



can be updated during the study by entering it in an administrative page of the MARVIN system. Before switching to the CARA algorithm, MARVIN allows to randomize the first 50 patients using a conventional list.

**Figure 2.2: The screenshot shows how a site is allocated to a specific study. Each site can be allocated to several studies.**

Center	00 - Registration	01 - GPOH-1	02 - GPOH-2	03 - RIST-INB-2011	04 - COALL 08-09	05 - EURO-HIT-HLH	06 - NHL-Registry	07 - IntReALL 2010	08 - I
Admin	<input checked="" type="checkbox"/>	<input checked="" type="checkbox"/>	<input checked="" type="checkbox"/>	<input checked="" type="checkbox"/>	<input checked="" type="checkbox"/>	<input checked="" type="checkbox"/>	<input checked="" type="checkbox"/>	<input checked="" type="checkbox"/>	<input checked="" type="checkbox"/>
D-Berlin, OH	<input checked="" type="checkbox"/>	<input type="checkbox"/>	<input type="checkbox"/>	<input checked="" type="checkbox"/>	<input checked="" type="checkbox"/>	<input type="checkbox"/>	<input type="checkbox"/>	<input checked="" type="checkbox"/>	<input type="checkbox"/>
IntReALL-SR-Studienzentrale	<input checked="" type="checkbox"/>	<input type="checkbox"/>	<input type="checkbox"/>	<input type="checkbox"/>	<input type="checkbox"/>	<input type="checkbox"/>	<input type="checkbox"/>	<input checked="" type="checkbox"/>	<input type="checkbox"/>
IntReALL-SR Sweden	<input type="checkbox"/>	<input type="checkbox"/>	<input type="checkbox"/>	<input type="checkbox"/>	<input type="checkbox"/>	<input type="checkbox"/>	<input type="checkbox"/>	<input checked="" type="checkbox"/>	<input type="checkbox"/>
MHH	<input checked="" type="checkbox"/>	<input type="checkbox"/>	<input type="checkbox"/>	<input checked="" type="checkbox"/>	<input checked="" type="checkbox"/>	<input type="checkbox"/>	<input type="checkbox"/>	<input checked="" type="checkbox"/>	<input type="checkbox"/>
RELAML-Studienzentrale Deutschland	<input type="checkbox"/>	<input type="checkbox"/>	<input type="checkbox"/>	<input type="checkbox"/>	<input type="checkbox"/>	<input type="checkbox"/>	<input type="checkbox"/>	<input type="checkbox"/>	<input type="checkbox"/>
RELAML-Studienzentrale Österreich	<input type="checkbox"/>	<input type="checkbox"/>	<input type="checkbox"/>	<input type="checkbox"/>	<input type="checkbox"/>	<input type="checkbox"/>	<input type="checkbox"/>	<input type="checkbox"/>	<input type="checkbox"/>
S-Lund, POH	<input checked="" type="checkbox"/>	<input type="checkbox"/>	<input type="checkbox"/>	<input type="checkbox"/>	<input type="checkbox"/>	<input type="checkbox"/>	<input type="checkbox"/>	<input checked="" type="checkbox"/>	<input type="checkbox"/>
Studie IntReALL-SR	<input checked="" type="checkbox"/>	<input type="checkbox"/>	<input type="checkbox"/>	<input type="checkbox"/>	<input type="checkbox"/>	<input type="checkbox"/>	<input type="checkbox"/>	<input checked="" type="checkbox"/>	<input type="checkbox"/>
SZ Hamburg	<input type="checkbox"/>	<input type="checkbox"/>	<input type="checkbox"/>	<input type="checkbox"/>	<input checked="" type="checkbox"/>	<input type="checkbox"/>	<input type="checkbox"/>	<input type="checkbox"/>	<input type="checkbox"/>
SZ Schweden	<input checked="" type="checkbox"/>	<input type="checkbox"/>	<input type="checkbox"/>	<input checked="" type="checkbox"/>	<input checked="" type="checkbox"/>	<input type="checkbox"/>	<input type="checkbox"/>	<input type="checkbox"/>	<input type="checkbox"/>
Testzentrum	<input checked="" type="checkbox"/>	<input checked="" type="checkbox"/>	<input checked="" type="checkbox"/>	<input checked="" type="checkbox"/>	<input checked="" type="checkbox"/>	<input checked="" type="checkbox"/>	<input type="checkbox"/>	<input checked="" type="checkbox"/>	<input type="checkbox"/>
Testzentrum Lund	<input checked="" type="checkbox"/>	<input type="checkbox"/>	<input type="checkbox"/>	<input checked="" type="checkbox"/>	<input type="checkbox"/>	<input type="checkbox"/>	<input type="checkbox"/>	<input type="checkbox"/>	<input type="checkbox"/>

#### 1.3.2.4.5 T2.4, 5) Monitoring tools:

For monitoring, a change in the database structure was required. The role depended “Patient-Visit-Matrix” requires a constant re-calculation of a role-based view of the complete database. The clinical data as well as the metadata in the core database are now synchronized to the reporting database in a robust and reliable way. The role-based views necessary for the “Patient-Visit-Matrix” are now created and updated on the reporting database without influencing the end user experience and data entry.

The MARVIN system has been upgraded significantly to provide the “Patient-Visit-Matrix” as a sortable and filterable interactive matrix report, the so-called “Subject status page”. This allows to quickly see the status of all patients with their visit status in the system (completion status, query status, signature/lock status, SDV status). From the “Subject status page”, users can directly jump into the relevant CRF pages to review data or perform other tasks.

Furthermore, the usability of the “Subject status page” has been improved, e.g., by freezing the identifier columns and the header of the table. In addition, specifications were written to enhance the subject status page such that planned and overdue visits will be displayed with different warning icons.

In addition, XClinical has started integrating a new ad hoc interactive web reporting technology that will enable users to quickly create new reports directly within the MARVIN web pages (this should also be possible across different studies/databases).





Figure 2.3: Screenshot of the Patient-Visit-Matrix.

Recruiting center	Subject Id	Registration IntReALL	SR - Trial admittance	SR - 1st Randomisation	SR - Primary ALL	SR - Relapse diagnostics	SR - Phase 1	SR - 2nd Randomisation	SR - MRD	SR - SAE 001	Σ
Testzentrum	123456	✓	✓	✓	!	!	!	!		!	
Testzentrum	GPOH.00328	!									
Testzentrum	GPOH.00417	✓	✓	✓			✓		✓	Q	
A-Wien, St. Anna Kinderspital, POH	GPOH.00439										
Testzentrum	GPOH.00461	✓	✓								
Testzentrum	GPOH.00462	✓	✓	✓					✓		
Testzentrum	GPOH.00463	✓									
Testzentrum	GPOH.00465	!									
Incomplete entries		2	0	0	1	1	1	1	0	1	7
Open queries		0	0	0	0	0	0	0	0	1	1
Complete entries		1	0	0	0	0	0	0	1	0	2
Signature level 1:		4	4	3	0	0	1	0	0	0	12
Signature level 2:		0	0	0	0	0	0	0	0	0	0
Signature level 3:		0	0	0	0	0	0	0	1	0	1

### 1.3.2.5 T 2.5: Perform interim and final analyses

Interim analyses have been performed for each of the DSMB meetings and the respective DSMB report. A formal interim analysis as mentioned in the statistics section on the statistical endpoints of the trial has not yet been performed, because the SR trial has not yet reached the interim analysis point. This analysis will be performed after 4 year of starting the recruitment, i.e. May 2018 at the earliest. Interim analyses for the HR trial will be performed after recruiting 50 patients and after every 25 patients thereafter. The first analysis will be reached at the end of 2018 at the earliest.

### 1.3.2.6 T 2.6: Planning publications of the results

A publication on the design of the SR trial as poster presentation has been released<sup>4</sup>. A manuscript for the design of the SR trial has been written and circulated and awaits a final approval of the trial committee. A publication on the final results of the SR trial will be done 3 years after recruitment of the last patient (mid 2019), presumably in summer 2022. A publication on the statistical design of the HR trial has been released as poster presentation<sup>5</sup>. A manuscript is planned for 2018. A publication on final results addressing the primary endpoint remission rates will be written the earliest after preterm termination of 100 patients in the end of 2019 or after full recruitment in 2021. Event-free survival results can be addressed the earliest 3 years later.

<sup>4</sup> Arend von Stackelberg, Cathy Qi, Vaskar Saha, Franco Locatelli, Joanna Moschandreas, Sharon Love. IntReALL SR 2010: An international randomised phase III study for the treatment of standard risk childhood relapsed acute lymphoblastic leukaemia (abstract). In: NCRI Cancer Conference; Nov 5-8, 2017; Glasgow. NCRI; Available from: [http://abstracts.ncri.org.uk/year\_published/2017/].

<sup>5</sup> Holmes J; Love SB; Vaskar S; von Stackelberg A: IntReALL HR and the benefits of adaptive design. Trials 2015 16(Suppl 2): abstract P2016. In: 3<sup>rd</sup> International Clinical Trials Methodology Conference 2015; Nov 16-17, 2015; Glasgow. ITCMC; Available from: [https://www.biomedcentral.com/].



### 1.3.3 Work package 3: Diagnostics and biological research

The objectives of work package 3 are standardization of diagnostics and biological monitoring in IntReALL 2010, standardization of tissue bank linked to IntReALL 2010, analysis of prognostic and predictive genetic changes.

#### 1.3.3.1 T 3.1 Standardization of diagnostics and monitoring in IntReALL

The standardisation of diagnostics is divided into subgroups: morphology, immunophenotyping, MRD by flow cytometry and PCR, and molecular genetics and cytogenetics. Responsibilities have been distributed to experts from participating countries. They have established a network between national reference laboratories represented by the national representatives for diagnostics and have discussed and written guidelines. SOP's for the diagnostic tests have been written and provided to the involved laboratories.

##### 1.3.3.1.1 Minimal Residual Disease (MRD)

MRD is measured nationally by standard PCR methods as established by the EuroMRD network. Quality control rounds and meetings have already been established and protocols with guidelines for MRD assessment via PCR have been incorporated in the IntReALL 2010 trials. Flow cytometry for MRD assessment is performed in parallel at all required MRD time-points, but will be used only for stratification, if a sensitive PCR assay cannot be established<sup>6</sup>. A flow network meeting was held on 31/05/2013 and an SOP has been circulated and accepted. One of the issues in this consortium is that though genomic analysis of Ig/TCR gene rearrangements is the preferred method for MRD detection, not all groups use this method routinely. A multicentre comparison of flow cytometry with genomic MRD has now been performed showing good concordance, sufficient for trial requirements.

##### 1.3.3.1.2 Flow Cytometry

Flow cytometry has been harmonised with central reference laboratories. SOP's have been defined. The issue of monitoring CD22 when using an anti-CD22 antibody as therapy has been resolved.

IntReALL 2010 flow cytometry issues and standardisation rounds were discussed at a meeting in May 2015 in Budapest. Further steps in collaboration were defined.

##### 1.3.3.1.3 Molecular genetic characterisation:

Concerning molecular genetic characterisation of samples, an IntReALL 2010 cytogenetic network has been established. National group representatives have been identified and contacted. The essential tests will include the identification of principle genetic abnormalities for BCP-ALL with ETV6-RUNX1, TCF3-PBX1, MLL translocations, BCR-ABL, E2A-HLF, IgH translocations, near haploidy, low hypodiploidy, high hyperdiploidy, iAMP21. For T-cell ALL these are TAL1, TLX3, TLX1 and LMO2 rearrangements as well as MLL translocations and AF10. Recommended tests include screening for secondary abnormalities such as deletions, CRLF2 abnormalities, CDKN2A/B deletions and TP53 deletions and mutations. Furthermore,

---

<sup>6</sup> Karawajew L, Dworzak M, Ratei R, Rhein P, Gaipa G, Buldini B, Basso G, Hrusak O, Ludwig WD, Henze G, Seeger K, von Stackelberg A, Mejstrikova E, Eckert C. Minimal residual disease analysis by eight-color flow cytometry in relapsed childhood acute lymphoblastic leukemia. *Haematologica*. 2015 Jul;100(7):935-44. PubMed PMID: 26001791. Pubmed Central PMCID: 4486228.

the group has developed a uniform genetics screen using a standardised platform for all samples<sup>7</sup>.

**Figure 3.1: Database - ER model, simplified**

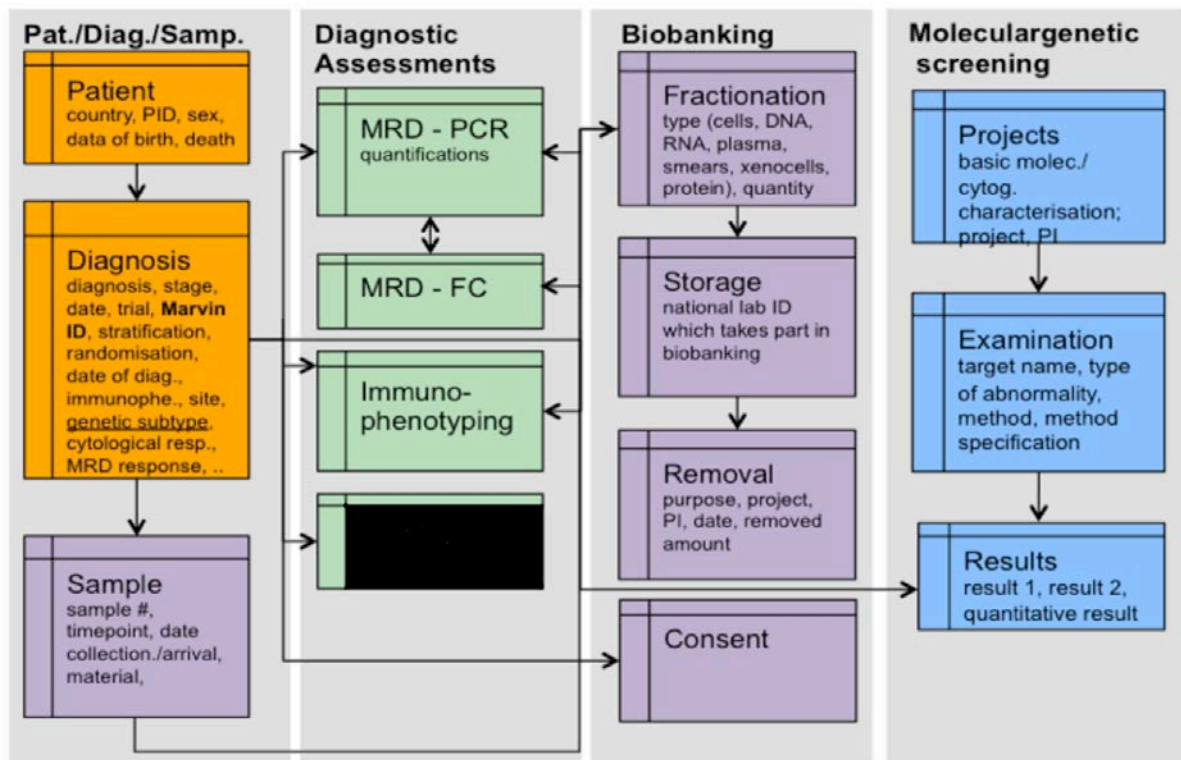

### 1.3.3.2 T 3.2: Standardization of tumour banking, collection/storage of patient material

Central point of the virtual IntReALL 2010 tumour bank is the web-based database system. Based on the entity-relationship (ER) model further development of the different applications has been done as immunophenotyping, biobanking and molecular genetic screening. Cytology has been removed. Consent is also not required as this is obtained nationally and has local requirements. The interface to the clinical MARVIN database has been extended to morphological and diagnostic genetic data, the role & rights system has been discussed and optimised and a solution for the integration of national different consent forms has been identified. Moreover, a proper tool for simple reports of material availability of defined cohorts has been discussed as well as the manual import of national biobank / laboratory data by an XML interface. IntReALL partners are integrated in the different work processes of the database development (Figure 3.2).

SOP's for biobanking have been developed and approved. The cost of the multifunctional Scopeland database was only partially funded by the FP7 programme and needs to be completed from other resources provided by the involved partners. The use of the database

<sup>7</sup> Irving JA, Enshaei A, Parker CA, Sutton R, Kuiper RP, Erhorn A, Minto L, Venn NC, Law T, Yu J, Schwab C, Davies R, Matheson E, Davies A, Sonneveld E, den Boer ML, Love SB, Harrison CJ, Hoogerbrugge PM, Revesz T, Saha V, Moorman AV. Integration of genetic and clinical risk factors improves prognostication in relapsed childhood B-cell precursor acute lymphoblastic leukemia. *Blood*. 2016;128(7):911-22.



allows two types of functionality. Direct input from groups who do not have their own system or uploading of field restricted flat file outputs from groups who already use their own database.

**Figure 3.2: Task and FP7 partner integration for the development of a web-based database system**

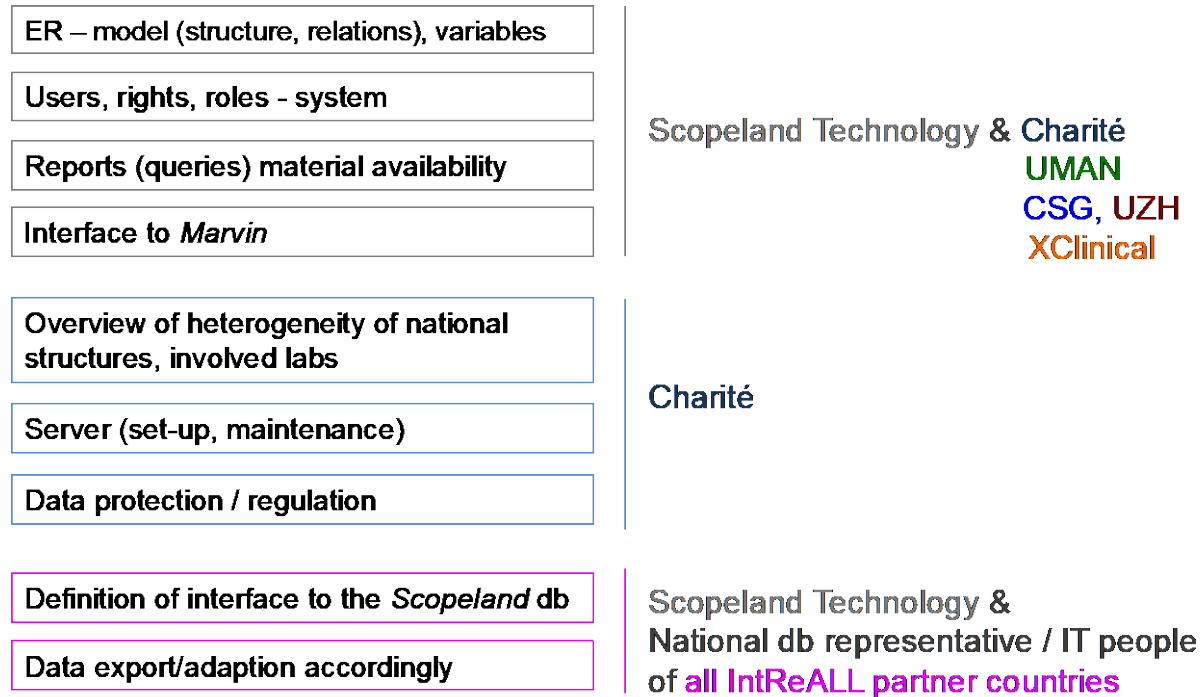

### 1.3.3.3 T 3.3: Genetic characterization of involved paediatric leukaemias

A pipeline for targeted NGS of IntReALL 2010 and PDX samples by the partner company GenomeScan (former ServiceXS), including samples provision, data storage and bioinformatic analysis has been established. Novel potential relevant genetic markers have been added to a defined list of principal genetic abnormalities. A procedure defined by the biology/diagnostics group of the Consortium for genetic characterisation of IntReALL 2010 samples has been successfully integrated into the routine diagnostics for relapsed ALL in the different countries. Data are partly reported to clinical departments and therefore documented in the clinical database MARVIN and imported to the Scopeland database or directly entered.

**Figure 3.3: Overview of sample flow within IntReALL**

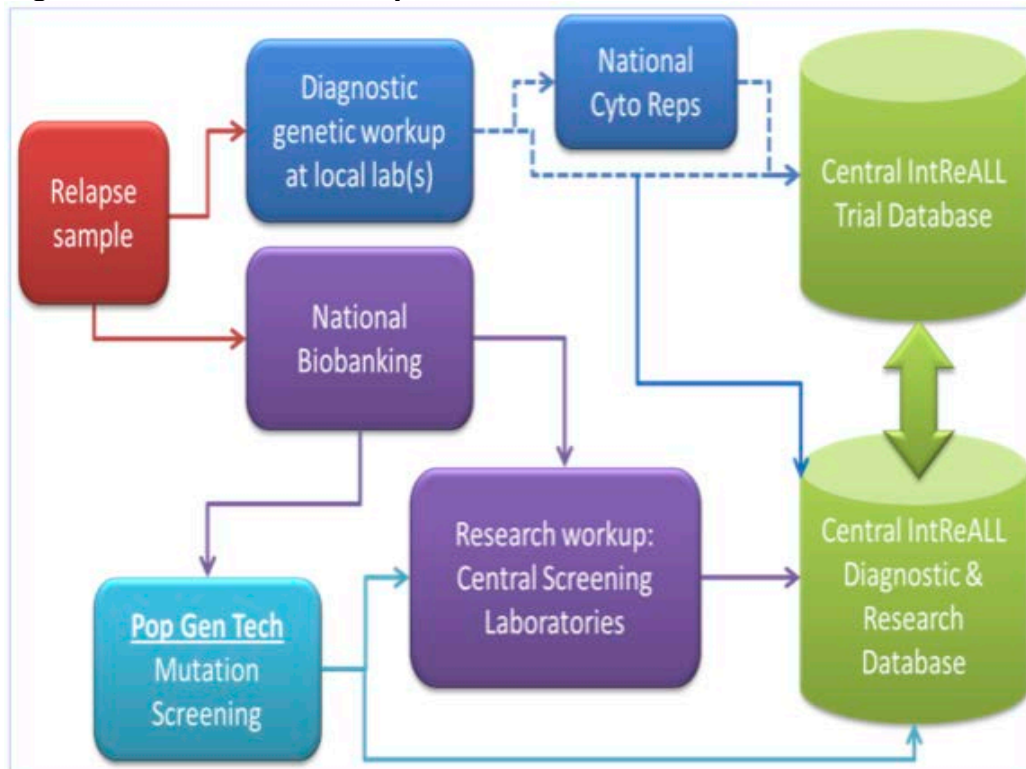

All molecular cytogenetic data from both the relapse and initial diagnostic samples are being captured. Any other existing molecular cytogenetic data available from the initial diagnosis of ALL is also being captured. The data from the relapse samples are standardised as per established guidelines. No additional testing of the initial diagnostic samples is required. A detailed list of key genetic abnormalities to be identified, separate for B and T-cell ALL, and the techniques that can be used have been agreed on.

All molecular cytogenetic data are being entered into a centralised database, which contains both trial and research sections. The database is being developed in collaboration with Scopeland Technology. Access will be via a secure web site.

Each national representative for cytogenetics is responsible for ensuring that data from his / her country is entered onto the database every 6 months. It will be possible to upload the molecular cytogenetic data automatically provided that the data is in the correct format. A precise definition of the acceptable format is being provided. Alternatively, data can be manually entered on a case-by-case basis. In this situation, the national representative can choose to enter the data himself / herself or devolve responsibility to individual genetic laboratories. However, if they choose the latter they are still responsible for the correctness of the data. Each national cytogenetic representative will only be able to access cases from his / her own country.

#### **1.3.3.3.1 Candidate gene next generation sequencing project**

In the era of massive parallel sequencing and elucidation of the cancer genome, we have utilised this opportunity to investigate the role of recurrent mutations as prognostic and/or predictive biomarkers to refine risk stratification for future clinical trials and prioritise the evaluation of novel therapies. At the start of the FP7 programme, we had partnered with





Population Genetics (Cambridge). However, they subsequently withdrew from cancer diagnostics and are no longer part of the consortium. We acquired a new partner in period 3, GenomeScan B.V. (formerly Service XS; Leiden). With a new partner, we now have the advantage of newer technology and more in depth reads at the same cost. Our target was to sequence ~1000 patients for >50 genes at >200x depth and members of the WP3 subgroup have compiled an appropriate gene list. A pilot study was performed using Sure Select Technology for target gene enrichment and Illumina technology for sequencing patient samples with spiked cell lines with well characterised mutations. The data was excellent, with a horizontal coverage of >99%, average read depth of ~1000 fold, a limit of detection of at least 3%, and a sensitivity of 91% in detecting mutations.

Numeric aberrations were originally planned with a candidate gene approach using multiplex-ligation dependent probe amplification. In order to gain the maximum amount of genetic information of potentially prognostic and targetable lesions, we decided to use single nucleotide polymorphism (SNP) arrays which have been financed by national sources. Exchange of experience with different SNP arrays, a standardised way of analysis and reporting of the data is in process.

A total of 570 samples have been analysed from 13 countries. These include 461 primary patient samples and 109 patient derived xenografts (PDX's) generated from relapsed patients. Paired samples from relapse and initial diagnosis were available in 75% of patients. Fastq files generated have been analysed by experts from Zurich and Kolkata. Informatics analyses have been completed for the first batch of 192 samples. We reported on the first 96 samples (a combination of patient and PDX samples) which were used as to test the workflow in the 4<sup>th</sup> periodic report. A more detailed analysis was published<sup>8</sup> and identified potential new drugs for use in childhood ALL. A next batch of 96 samples has been analysed and delivered as result to the project. The final analyses of the remaining samples is due to be completed by the end of 2017.

For the patient samples, a mutation was detected in 85%. 35% and 18% had mutations within RAS and CREBBP genes respectively.

Further steps are to complete sequencing and generation of Fastq files on the remaining 372 samples by the end of 2017, to complete of data analysis and collection of numeric aberrations by April 2018, and to complete informatics analysis of all data by April 2018.

Integrated analyses of diagnostic and clinical data are planned to be available by September 2018, a draft complete analyses by end 2018.

---

<sup>8</sup> Frismantas V, Dobay MP, Rinaldi A, Tchinda J, Dunn SH, Kunz J, et al. Ex vivo drug response profiling detects recurrent sensitivity patterns in drug-resistant acute lymphoblastic leukemia. *Blood*. 2017;129(11):e26-e37.





### **1.3.4 Work package 4: Networking, dissemination and regulatory affairs**

The overall objectives of WP4 are the establishment and maintenance of a network with academic structures (e.g. ITCC, ENCCA, I-BFM-SG, SIOPe), pharmaceutical industry and authorities (EMA) and the integration of parent groups for drug development and treatment in childhood relapsed / refractory ALL. We also aimed at obtaining a fruitful interaction among the participating groups, a better dissemination of clinical and scientific findings and sharing of all available expertise with the scope of achieving optimal study design for any available new drug with adequate integration of interests of the patients and their families.

#### **1.3.4.1 T 4.1: Networking with academic community and parent organizations**

The network between Members and both academic and parent organizations has been continued throughout the project. Routinely, both IntReALL meetings and Meetings of the Resistant Disease Working Group of the I-BFM group have been organized. During these Meetings, discussions and sharing of the different objectives of the project have been taken forward. Updates of the development of all activities concerning the IntReALL FP7 project have been given. In particular, after implementation of the SR trial, measures to improve patient recruitment have been discussed. Members of the IntReALL Consortium have supported to organize a common randomized trial comparing the combination of TBI and Etoposide versus a chemotherapy-based regimen, which will include Thiotepa, Fludarabine and Busulfan or Treosulfan. This randomized clinical trial has already recruited a relevant number of patients from many centres and countries, which are involved in the IntReALL consortium.

At the New Drugs Development Strategy (NDDS) meeting held on October 16 and 17, 2012 in Paris, which has been organized with the ENCCA consortium, the ITCC, the EMA, and ALL disease experts (I-BFM SG [International BFM Study Group], COG [Children's Oncology Group, USA] members), key leaders of the IntReALL project have contributed to define a priority plan for drug development in children with relapsed/refractory ALL.

The integration of parents into the design, planning and conduct of clinical trials in children with cancer has become a routine and is continued within the IntReALL FP7 project. The International Confederation of Childhood Cancer Parent Organizations (ICCCPO) recently renamed in Childhood Cancer International (CCI) has nominated representatives participating in the IntReALL project and joining the Ethics Board. During the annual IntReALL meetings, representatives of the Ethics Board and the CCI have always been present to monitor and advice on the project consortium. They have hold several session with the aim to identify ethical problems related to the IntReALL and phase I/II trials experienced by the investigators and to develop strategies how to address them.

The consortium's dissemination and publication activities demonstrate an active and worldwide communication of the progress of the IntReALL trial to the scientific and medical community. A detailed list of the consortium's dissemination and publication activities is provided via the Participant Portal.



**Figure 4.1 List of Publications**

Title	Author(s)	Title of the periodical or the series	Number, date or frequency	Publisher	Place of publication	Date of publication	Relevant pages
How I treat relapsed childhood acute lymphoblastic leukemia	Locatelli F	J. of the American Society of Hematology	Oct 2012			15/08/2012	2807 - 16
Management of relapsed acute lymphoblastic leukemia in childhood with conventional and innovative approaches.	Locatelli F, Moretta F, Rutella S	Current Opinion in Oncology	25	Lippincott Williams and Wilkins		05/11/2013	707-15
Minimal residual disease analysis by eight-color flow cytometry in relapsed childhood acute lymphoblastic leukemia	Karawajew L, Dworzak M, Ratei R, Rhein P, Gaipa G, Buldini B, Basso G, Hrusak O, Ludwig WD, Henze G, Seeger K, von Stackelberg A, Mejstrikova E, Eckert C.	Haematologica	pii: haematol.2014.116707	Ferrata Storti Foundation		02/05/2015	Epub ahead of print
Monitoring minimal residual disease in children with high-risk relapses of acute lymphoblastic leukemia: prognostic relevance of early and late assessment	Eckert C, Hagedorn N, Sramkova L, Mann G, Panzer-Grümayer R, Peters C, Bourquin JP, Klingebiel T, Borkhardt A, Cario G, Alten J, Escherich G, Astrahantseff K, Seeger K, Henze G, von Stackelberg A	Leukemia	doi: 10.1038/leu.2015.59	Nature Publishing Group		09/03/2015	Epub ahead of print
Phase I/Phase II Study of Blinatumomab in Pediatric Patients With Relapsed/Refractory Acute Lymphoblastic Leukemia	Arend von Stackelberg, Franco Locatelli, Gerhard Zugmaier, Rupert Handgretinger, Tanya M. Trippett, Carmelo Rizzari, Peter Bader, Maureen M. O'Brien, Benoit Brethon, Deepa Bhojwani, Paul Gerhardt Schlegel, Arndt Borkhardt, Susan R. Rheingold, Todd Michael Cooper, Christian M. Zwaan, Phillip Barnette, Chiara Messina, Gérard Michel, Steven G. DuBois, Kuolung Hu, Min Zhu, James A. Whitlock, Lia Gore	Journal of Clinical Oncology	Vol. 34/Issue 36	American Society of Clinical Oncology	United States	20/12/2016	4381-4389
Ex vivo drug response profiling detects recurrent sensitivity patterns in drug-resistant acute lymphoblastic leukemia	Viktoras Frisimantas, Maria Pamela Dobay, Anna Rinaldi, Joelle Tchinda, Samuel H. Dunn, Joachim Kunz, Paulina Richter-Pechanska, Blerim Marovca, Orrin Pail, Silvia Jenni, Ernesto Diaz-Flores, Bill H. Chang, Timothy J. Brown, Robert H. Collins, Sebastian Uhrig, Gnana P. Balasubramanian, Obul R. Bandapalli, Salome Higi, Sabrina Eugster, Pamela Voegeli, et al.	Blood	Vol. 129/Issue 11	American Society of Hematology	United States	16/03/2017	e26-e37
Minimal residual disease analysis by eight-color flow cytometry in relapsed childhood acute lymphoblastic leukemia	L. Karawajew, M. Dworzak, R. Ratei, P. Rhein, G. Gaipa, B. Buldini, G. Basso, O. Hrusak, W.-D. Ludwig, G. Henze, K. Seeger, A. von Stackelberg, E. Mejstrikova, C. Eckert	Haematologica	Vol. 100/Issue 7	Ferrata Storti Foundation	Italy	01/07/2015	935-944
Integration of genetic and clinical risk factors improves prognostication in relapsed childhood B-cell precursor acute lymphoblastic leukemia	Julie A. E. Irving, Amir Enshaei, Catriona A. Parker, Rosemary Sutton, Roland P. Kuiper, Amy Erhorn, Lynne Minto, Nicola C. Venn, Tamara Law, Jiangyan Yu, Claire Schwab, Rosanna Davies, Elizabeth Matheson, Alysia Davies, Edwin Sonneveld, Monique L. den Boer, Sharon B. Love, Christine J. Harrison, Peter M. Hoogerbrugge, Tamas Revesz, Vaskar Saha, Anthony V. Moorman	Blood	Vol. 128/Issue 7	American Society of Hematology	United States	18/08/2016	911-922
The combination of bortezomib with chemotherapy to treat relapsed/refractory acute lymphoblastic leukaemia of childhood	Alice Bertaina, Luciana Vinti, Luisa Strocchio, Stefania Gaspari, Roberta Caruso, Mattia Algeri, Valentina Coletti, Carmelo Gurnari, Mariateresa Romano, Maria Giuseppina Cefalo, Katia Girardi, Valentina Trevisan, Valentina Bertaina, Pietro Merli, Franco Locatelli	British Journal of Haematology	Vol. 176/Issue 4	Blackwell Publishing	United Kingdom	01/02/2017	629-636
Neurotoxic side effects in children with refractory or relapsed T-cell malignancies treated with nelarabine based therapy	Michaela Kuhlén, Kirsten Bleckmann, Anja Mörcke, Martin Schrappe, Simon Vieth, Gabriele Escherich, Annika Bronsema, Annika Vonalt, Manon Queudeville, C. Michel Zwaan, Martin Ebinger, Klaus-Michael Debatin, Thomas Klingebiel, Ewa Koscielniak, Claudia Rossig, Birgit Burkhardt, Reinhard Kolb, Cornelia Eckert, Arndt Borkhardt, Arend von Stackelberg, Christiane Chen-Santel	British Journal of Haematology	Vol. 179/Issue 2	Blackwell Publishing	United Kingdom	01/10/2017	272-283

#### 1.3.4.2 T 4.2: Networking with regulatory authorities and industry

Throughout the project, members of the IntReALL 2010 consortium have continued to actively promote the interaction with regulatory authorities and industry to warrant effective drug development for children with ALL in the best interest of the patients. Companies with interesting compounds and projects for childhood relapsed/refractory ALL have been invited to selected meetings where strategies can be agreed upon as early as possible to achieve realistic Paediatric Investigational Plans (PIP's) that fit the future strategies of the consortium. The IntReALL 2010 consortium continues to search for interesting compounds, actively contact manufacturers and start early interaction. Within IntReALL trials, those patients who either are non-responding or experience multiple relapses can be, thus, quickly identified, this rendering them eligible for being included into experimental phase I/II trials conduction in centres of excellence in the different European Countries.

As major achievement, the phase I dose finding and phase II early activity studies on Blinatumomab, a bispecific CD3/19 directed T-cell engaging monoclonal antibody sponsored by the manufacturer Amgen has been successfully completed and published<sup>9</sup>. Members of the Consortium have been significantly involved in the study design investigating the efficacy and toxicity of Blinatumomab in comparison with conventional intensive combination chemotherapy as scheduled in the IntReALL HR 2010 design (HC3 course) within the IntReALL HR investigational window.

Another investigator-driven study (Sponsor Erasmus University of Rotterdam, PI Dr. G. Kaspers from Amsterdam) which has tested the safety and efficacy of a proteasome inhibitor (Bortezomib) in combination with conventional drugs used for ALL (i.e. dexamethasone and vincristine) has been completed and the results have been presented at the Annual 2014

<sup>9</sup> von Stackelberg A, Locatelli F, Zugmaier G, Handgretinger R, Trippett TM, Rizzari C, Bader P, O'Brien MM, Brethon B, Bhojwani D, Schlegel PG, Borkhardt A, Rheingold SR, Cooper TM, Zwaan CM, Barnette P, Messina C, Michel G, DuBois SG, Hu K, Zhu M, Whitlock JA, Gore L. Phase I/Phase II Study of Blinatumomab in Pediatric Patients With Relapsed/Refractory Acute Lymphoblastic Leukemia. J Clin Oncol. 2016 Dec 20;34(36):4381-9. PubMed PMID: 27998223.



Meeting of the American Society of Haematology. Pilot data have been generated and published by the Italian group on the efficacy of Bortezomib in children with refractory/resistant BCP- and T-ALL<sup>10</sup>. Furthermore, members of the Consortium have been significantly involved in the study design for testing the safety and efficacy of a new proteasome inhibitor (i.e. Carfilzomib) in combination with cytotoxic agents used for treating children with refractory/relapsed ALL. A study on T-ALL (NECTAR study) aimed at testing safety/efficacy of Nelarabine in combination with Cyclophosphamide and Etoposide for patients with multiple relapsed/refractory disease has been approved in the two European coordinating centres (Erasmus University of Rotterdam and Ospedale Bambino Gesù Roma) and has recruited patients. Collaboration has started with the Novartis Company to elaborate a common strategy for testing the use of JAK2 inhibitors in children with Ph-like relapsed/refractory ALL who carry genetic lesions potentially targetable with this drug.

A phase I/II trial investigating the drug Moxetumomab Pasudotox, an immunotoxin with a CD22 directed truncated monoclonal antibody linked to a pseudomonas toxin derivate has been opened first in the USA and then in Europe, but has been stopped preterm due to toxicity and insufficient efficacy.

Pfizer has delegated sponsorship to the University Erasmus Rotterdam to perform a phase I/II trial in children with relapsed/refractory ALL with the immunotoxin Inotuzumab Ozogamicin (IO), a CD22 directed monoclonal antibody linked to the lymphotoxic compound calicheamicin. Data from trials with adult patients show very favourable results making this drug promising for the paediatric indication. The trial has recently been opened in the sponsor institution and will be subsequently opened in European phase I/II centres. The IntReALL Consortium has actively promoted this trial and considers IO a drug being suitable for future integration into the IntReALL HR treatment strategy. Accordingly, in the phase I/II trial next to a single drug approach, the combination with a modified ALL R3 induction regimen is investigated, which corresponds to the IntReALL HR induction.

Recently, the very important topic of chimeric receptor antigen T- cells (CAR-T-cells) came up based on data provided by the University of Philadelphia. CAR-T-cells directed against CD19 have shown a remarkable and persistent activity against B-cell precursor ALL. Novartis has taken over the product and set up a commercial platform with a large international phase I/II trial for children with ALL relapse. Several other initiatives to investigate CAR-T-cells with specific modifications have been undertaken since then, using different commercial and academic platforms.

#### **1.3.4.3 T 4.3: Awareness creation and public information**

Presentation of the IntReALL project in a well-established public website and presentation of the project and results at public and scientific events and conferences has constantly improved and maintained the awareness of the population on the problems of refractory and relapsed leukaemia in children and the way to find solutions within the European Union. The creation of the IntReALL public website was the first step for distribution of information and raising the awareness on the diagnosis/treatment of children with relapsed ALL. The IntReALL webpage [www.intreall-fp7.eu](http://www.intreall-fp7.eu) is a major communication tool for the general public. The webpage has been designed and set up by Partner tp21 and has been agreed upon by all partners. The

---

<sup>10</sup> Bertaina A, Vinti L, Strocchio L, Gaspari S, Caruso R, Algeri M, Coletti V, Gurnari C, Romano M, Cefalo MG, Girardi K, Trevisan V, Bertaina V, Merli P, Locatelli F. The combination of bortezomib with chemotherapy to treat relapsed/refractory acute lymphoblastic leukaemia of childhood. *Br J Haematol.* 2017 Feb;176(4):629-36.



IntReALL website offers two levels of information. Background information and valuable links are given on the literature page of the website and guide the visitors to international sites e.g. of the IntReALL partner ICCCO providing information in several international languages. Many thousands of web users have visited the IntReALL public website. The website will stay open at least 2 years beyond EU project duration.

**Fig. 4.2 IntReALL public website: [www.intreall-fp7.eu](http://www.intreall-fp7.eu)**

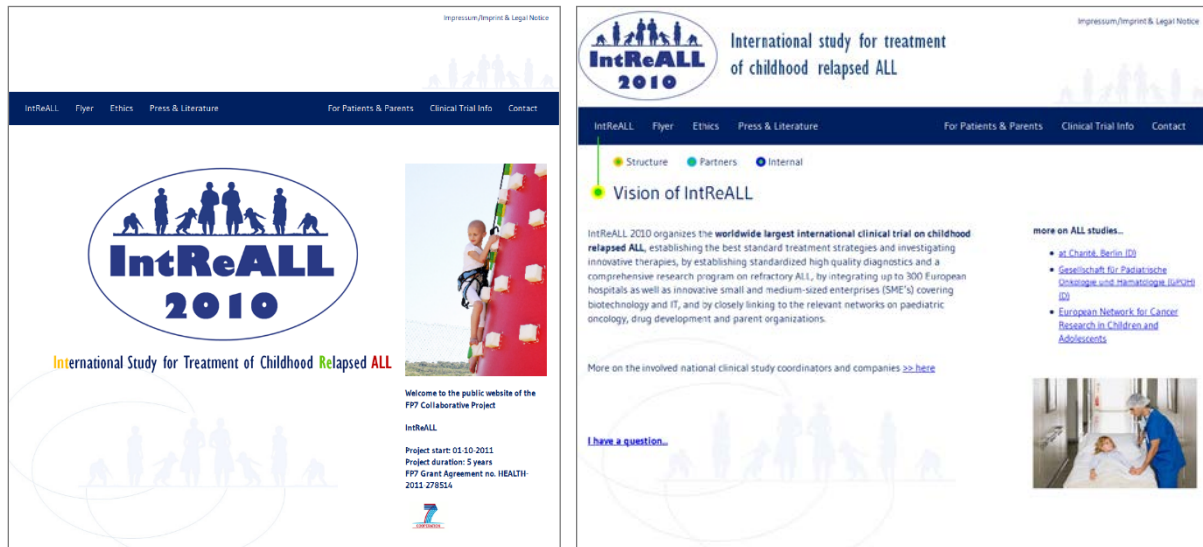

The Ethics Board has finalised a leaflet/brochure for patients and parents of children with standard risk relapsed ALL. The brochure provides parents and patients with basic and detailed information about the treatment for children and the IntReALL study in order to facilitate consideration and decision making for/ against the trial participation (of their child). The brochure is placed on the IntReALL website and can be downloaded by parents and patients. Printouts are available to all physicians who participate in the IntReALL study.



Fig. 4.3 IntReALL information brochure for parents

## IntReALL – International Study for the Treatment of Childhood Relapsed Acute Lymphoblastic Leukemia (ALL) – Standard Risk (SR)

### Information for Parents

The purpose of this flyer is to inform you about the treatment for children with standard risk relapsed ALL that is widely offered, and then provide you with detailed information about an international study which aims to explore how to improve the treatment of these children. Our purpose is to help you to understand the details of this study and consider whether you wish your child to take part.

#### 1. What is the standard treatment for children with SR relapsed ALL?

Several chemotherapy strategies have been developed to treat childhood relapsed ALL. Among those, there are two most widely used protocols in the treatment of relapsed ALL in Europe:

- The ALL-REZ BFM protocol (standard treatment initiated in Germany)
- The ALL R3 protocol (standard treatment initiated in the UK)

These protocols have never been compared with each other in the context of a research study. Each protocol has its own advantages and disadvantages yet both produce very good outcomes.

IntReALL | Information | 1

#### 2. What is the International Study for Relapsed ALL (IntReALL) that is being proposed for the treatment of my child?

The clinical trial that is being proposed for your child is the **International Study for Childhood Relapsed ALL (IntReALL)**. It is the **worldwide largest international clinical trial on relapsed ALL in childhood** which seeks to discover the best treatment strategies and investigates innovative therapies for children with relapsed ALL.

**This study has two aims:**

- to compare the two standard protocols (the ALL R3 protocol & the ALL-REZ BFM protocol described above) in order to determine which is the best for children with relapsed ALL, and
- to study the effectiveness of a new drug (named **Epratuzumab**) in relapsed leukemia.

This medical research study is a **clinical trial**.

➤ for more information about clinical trials go to: [www.cci.org](http://www.cci.org); [www.siope.eu](http://www.siope.eu) or [www.encca.eu](http://www.encca.eu)

#### 3. Who can participate in this study?

**All children** who are diagnosed with standard risk (SR) relapsed ALL. Your child is one of them. The more children take part, the more information can be gathered to help us improve the treatment of children with relapsed leukemia.

IntReALL | Information | 2

#### 4. What does it mean that IntReALL is a “randomized” study?

It means that if your child takes part, then he/she will be randomly **assigned** by a computer to one of the proposed treatment arms (referred to as “arm A” or “arm B”), to follow either the ALL-REZ BFM protocol or the ALL R3 protocol (➤ see page 1). Following the induction phase, a second randomization will assign patients to the respective standard consolidation therapy either with or without the new drug **Epratuzumab**. In other words, your child will be assigned to one of the following groups:

- Standard treatment ALL-REZ BFM and consolidation **with Epratuzumab** (Arm A)
- Standard treatment ALL-REZ BFM and consolidation **without Epratuzumab** (Arm A)
- Standard treatment ALL R3 and consolidation **with Epratuzumab** (Arm B)
- Standard treatment ALL R3 and consolidation **without Epratuzumab** (Arm B)

Each “**randomization**” is done by a computer. Half of the children who participate in the study are expected to receive the new drug **Epratuzumab**.

The IntReALL study has been designed by skilled experts based on the knowledge available up to date. The safety of patients in clinical trials, such as the IntReALL study, is of utmost importance. All trial protocols have been reviewed and approved by ethics and regulatory committees.

#### 5. How long is the treatment and what does it involve?

Regardless of the group to which your child will be randomly assigned, the treatment comprises the following four phases:

**1st phase: Induction phase** (treatment lasts 5 weeks)

- Very intensive therapy will be given with the aim to eradicate all – or at least most – malignant cells at the very beginning. We expect your child to remain in the hospital most of the time during this phase. At the end of this course we will check the bone marrow to assess if the disease is in remission.

### 1.3.4.4 T 4.4: Knowledge management

Annual meetings held in Rome, Berlin, Besancon, Stockholm, Manchester, Vienna, Zürich, and Brussels have reached the objective of creating the know-how on how to treat, in the best way, paediatric patients with relapsed ALL. In particular, the physicians/researchers attending these meetings have had the opportunity to get a firm understanding of the different biological aspects related to the diagnosis and treatment of relapsed ALL. An open, interactive discussion between the key leaders of the IntReALL consortium and other physician/scientists participating in the project has allowed analysing in depth all aspects playing a relevant role in the prognosis of paediatric patients with relapsed/refractory ALL: Moreover, two papers on how to treat relapsed ALL have been written by the Chairman of this Working Party 4 (Prof. Franco Locatelli, Ospedale Pediatrico Bambino Gesù Roma) and have been published in *Blood*, which is the most read and popular Journal among haematologists, and in *Current Opinion in Oncology*. In these articles, the most recent knowledge on the pathophysiology of ALL recurrence, the criteria used for patient stratification, and the outcome reported by the most credited paediatric cooperative groups worldwide have been addressed. Moreover, in these papers, it was discussed how to treat these patients and how novel therapies can be integrated into regimens for relapsed ALL. Two flow charts included in the paper published in *Blood* are reported below and have been presented during the Meetings in order to create full awareness on the best strategy to handle this complex clinical scenario.



Figure 4.4: Management of patients with relapsed ALL involving bone marrow.

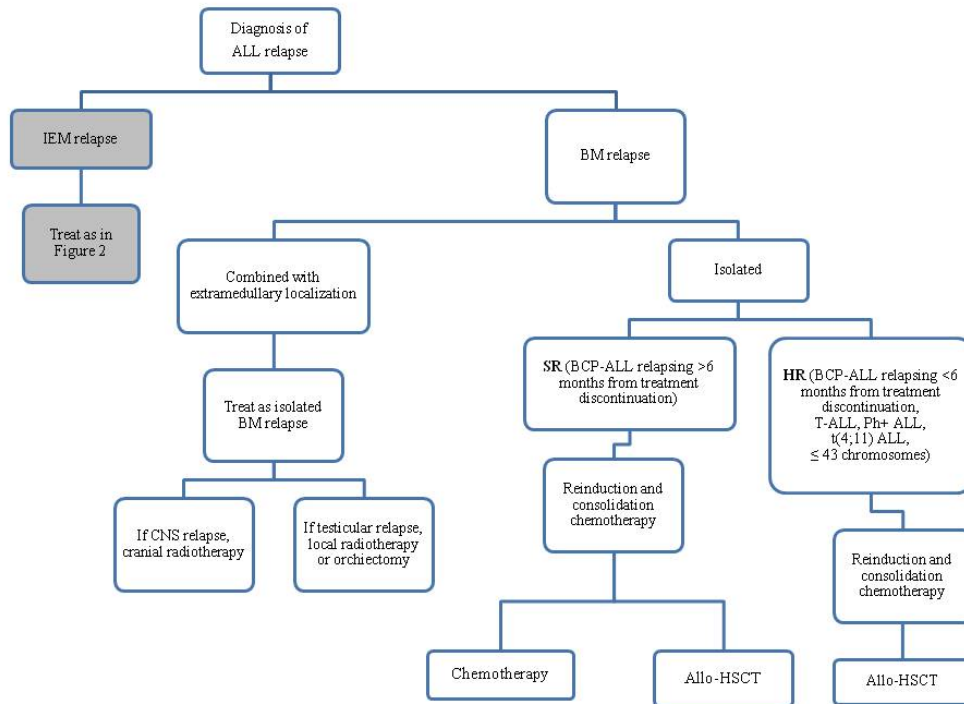
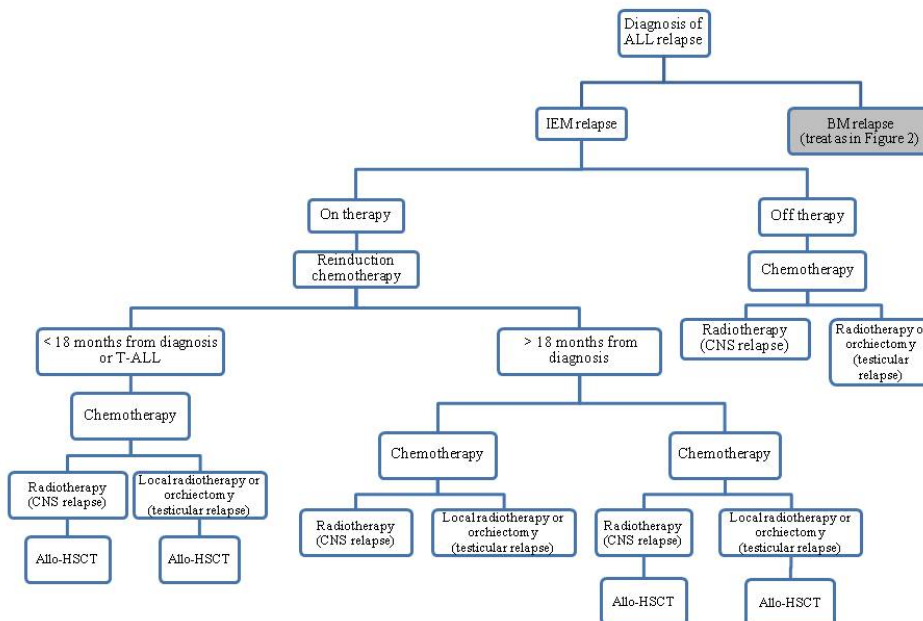

Figure 4.5: Management of patients with relapsed ALL involving extra-medullary sites.







By regular participation at annuals meetings organized by both, the IntReALL Consortium and the Resistant Disease Committee of the I-BFM family, with which IntReALL strictly collaborates, physicians involved in the clinical care of children with relapsed/refractory ALL have the opportunity to learn about the most recent advances in the field. This dissemination activity leads to homogenise the therapy of relapsed childhood ALL in Europe. Moreover, all participating investigator and scientists attending the informative IntReALL meetings have received newsletters and reports on the activity of the group.

#### **1.3.4.5 T 4.5: Training of young clinical personnel**

Training of young clinical personnel is provided by reporting strategies and results of the IntReALL Consortium in numerous small and large scientific meetings. These are regular meetings of the national scientific societies, where national co-ordinating PI's report on the IntReALL trials and the related biological investigations. These meetings are in part organized as formal trial investigator meetings as obligation of the sponsor to adequately inform PI's and involved staff on the progress of the IntReALL trial.

IntReALL partners do educate participants of large scientific congresses such as SIOP (International Society of Paediatric Oncology), ASCO (American Society of Clinical Oncology), or ASH (American Society of Haematology) by providing lectures to a large audience or giving education or "meet the expert" sessions to a smaller audience (see list of meetings in the participant portal).

### **1.3.5 Work package 5: Project management**

The goals of the project management are a smooth project implementation if administration and financial level, fulfilment of contractual obligations, targeted navigation of research/clinical study, early identification of problems, needs or inventions, and finally to ensure a successful collaboration within the consortium (WP5) and to support communication and networking beyond the consortium (WP4).

Therefore, a constant monitoring and steering of the tasks and deliverables of all WPs will enable the synchronization of all activities and, in case, will identify any delay or unexpected situation as early as possible. The management will support a proper and timely execution of all administrative and financial tasks.

Finally, the management team, mainly the coordinator, will faithfully interact with the EC's representatives. Regularly the management team will evaluate the innovation potential of the project results and supervise all contractual issues, incl. ethical, regulatory and gender issues.

#### **1.3.5.1 T 5.1: Administration**

The management team together with the WP-leaders were in charge of the monitoring and timely consolidation of the contractual reporting and the deliverable documentation. TP21 was in contact with all partners in order to ensure a timely cost reporting and delivery of information on dissemination activities. WP-leaders collaborated with the partners involved in their WPs to report on WP-level. The coordinator and TP21 consolidated all reports and, together with the WP-leaders, assessed the quality of the work performed, the progress, envisaged final steps as well as the resource consumption. Partners' administrative data and IntReALL budget status information have been maintained by CHARITE and TP21.



Within the 6 years of IntReALL, 13 scientific and management meetings have been held to mutually report and discuss on the work progress. Thereof were 8 FP7 only meetings including 1 Skye meeting and 5 networking meetings of the IntReALL consortium and the Resistant Disease committee of the I-BFM study group. At two meetings, an additional internal workshop was implemented.

At some plenary meetings, a formal General Assembly (GA) took place to decide on major issues:

- At the Month 18 Meeting, the GA decided to request electronic submission of financial statement in IntReALL. Partners have already nominated Financial Signatures for this procedure.
- At the Month 24 meeting, the GA decided to aim at a request for project extension in near future due to the delayed patient recruiting process.
- At the Month 30 Meeting, the GA unanimously voted for the Biotech Company Service XS to replace PopGenTech (partner 22) to deliver the genotyping for IntReALL samples. Furthermore, the GA accepted the exchange of the clinical partner in the Netherlands proposed by Radboud University Nijmegen Medical Center (RUNMC), partner 13.
- At the Month 60 Meeting, all present partners agreed on the suggested money re-distribution in case of a final EC approval of the 3<sup>rd</sup> Contract Amendment/project prolongation.

Additional bilateral meetings, study side visits and trainings within the consortium as well as networking meetings took place to coordinate the scientific activities within WP1, WP1 and WP3, to exchange information and to perform hands-on trainings.

These meetings include closed IntReALL sessions within I-BFM conferences, internal RTD meetings organised by the Biology Group (WP3), IntReALL database meetings (WP2) as well as national Trial Manager networking meetings (WP1) and bilateral meetings.

#### **1.3.5.2 T 5.2: Day-to-Day Management**

A number of means is being used to support a continuous project-internal communication and management: telephone calls, skype conferences, email exchange. TP21 was in contact with all partners in order to clarify questions on financial reporting, cost recording and meeting organisation.

#### **1.3.5.3 T 5.3: Progress Management**

The WP-leaders and the coordinator have monitored IntReALL progress by individual communication and at project meetings. In the frame of the final IntReALL management meeting, partners presented the status of their work progress as well as the planned next or final steps. Furthermore, the meeting presentations provided a survey on activities planned by partners in the months ahead until the finalisation of the SR and HR trial, also beyond the FP7 framework.

For the IntReALL trial in total 3 internal surveys have been implemented: 2 scientific progress surveys have been conducted to monitor the progress of the tasks, deliverables and milestones (M9, M33) and one financial assessment survey in M58.

The scientific surveys enabled all project partners to inform the consortium about the progress of their work, to give an overview of major control points, to detect early possible deviations from the Description of Work and other problems. The financial survey allowed all partners,



especially the clinical study groups, to update the consortium about the status of the trial / the actual recruitment numbers and the corresponding workload and costs. The progress surveys have been performed by TP21, assessed by the coordinator, and presented and discussed at the subsequent meetings. The data and the progress descriptions are implemented in the contractual reporting/ core of the report descriptions and deliverable reports.

The project-internal knowledge management platform has been used in all periods for internal information and knowledge sharing (TP21). All project documents have been managed via this platform and are available for all project partners. The platform is a SSL secured project-internal information, communication and knowledge management instrument and provides all data of the partners, full documentation of the meetings, IntReALL contract framework, a survey on deliverable reports and milestones, the progress reports, a reporting area and an up-load functionality for the partners for joint protocols and contract templates. The platform was permanently kept up-to-date by TP21. It will stay accessible for the partners for at least 2 years after EU project end.

#### **1.3.5.4 T 5.4: Legal and financial Management**

The IntReALL Consortium Agreement (CA) basing on the DESCAs 2 model was negotiated before the project start, and completed and signed by all beneficiaries at early project phase. After having entered in the consortium, new partners also joined the Consortium Agreement.

A total of 4 Contract Amendments have been released: the first in 2013, with inclusion of the new partner EORTC; the second in 2014, with exchange of SME partner PopGenTech by ServiceXS B.V.; the third in 2016, with prolongation of project duration for 12 months and withdrawal and replacement of clinical study groups in France and the Netherlands; the fourth in 2017, with partial transfer of rights and obligations (PTRO) from Genomic Investment B.V. (SXS) to GenomeScan B.V. (SXS2).

For contractual reporting, partners submitted their financial cost statements. The EC has accepted almost all claimed costs. After 72 project months, partners mobilised a total of 93 % of the planned total effort in the total project period.

As expected, the clinical partners showed increasing costs in the last period as the centres have been working routinely with opening of sites, recruiting and monitoring of patients and maintaining the ongoing studies. The Management and Dissemination costs are considered to be adequate compared to the RTD effort and the status of the project.

#### **1.3.5.5 T 5.5: Ethics Management**

An additional Ethics Board has been installed within the IntReALL consortium to monitor ethical aspects of the project not covered by the competent Ethics Committees. The board includes the parent representatives (CCI, formerly ICCCP), social scientists and philosophers. The board has reviewed and approved the protocols and information/consent forms for SR patients in different age groups and developed a questionnaire for clinicians regarding critical ethical issues and practical aspects in patient care. Representatives attend the regular autumn meetings of the Consortium.

In 2016 the Ethics Board has finalised a leaflet/brochure for patients and parents of children with standard risk relapsed ALL. The brochure provides parents and patients with basic and detailed information about the treatment for ALL children and the IntReALL trial in order to facilitate consideration and decision making for/ against trial participation (of their child).



Printouts of the final English booklet have been distributed to all clinical sites in order to be placed in the clinics. The English version is also available for download on the public IntReALL website [www.intreall-fp7.eu](http://www.intreall-fp7.eu) under the subpage „ For Patients and Families“.

The Ethics Board has addressed ethical complex and controversial cases and has developed a questionnaire that was distributed to all present physicians at first at the M36 meeting in Lisbon in September 2014 in order to find out what kind of critical ethical issues they are faced with in patient care.

Two re-assessments with the same questionnaire have been performed at the M48 meeting in Vienna (September 2015) and at the M66 meeting in Rome in September 2016 - after 1 year and after 2 years of SR trial experience, respectively.

At the final meeting in Berlin in September 2017, the Ethics Board has presented an overview on the results of the 2014 -2016 questionnaires. A comparison of the core ethical situation over time revealed that situations in which one is faced with ethical issues have changed: in 2014/2015, the most relevant ethical challenges were communication issues (decision-making regarding stopping treatment; conflict with decision-making), whereas in 2016 issues related to randomization were most prominent.

The core of the ethical situation in 2016 were presented and discussed:

- communication management problems related to the clinical trial
- communication between parents and medical staff
- issues with consent

A summary over time on the core ethical situation showed that the core issues went from challenges with end of life decision making and disagreement regarding consent (2014) to issues with consent and communication (2015) and to communication issues regarding the clinical trial. The main conclusion was that the situations require an improved communication (communication with parents and family, involving other team members, psychological support and discussing options) as well as more time for communication.

The importance of the Ethics Board and its role within the consortium has been discussed.

It would be highly desirable that the Ethics Board continues to stay with the group also after the end of the FP7 project.



## **1.4 THE POTENTIAL IMPACT (INCLUDING THE SOCIO-ECONOMIC IMPACT AND THE WIDER SOCIETAL IMPLICATIONS OF THE PROJECT SO FAR) AND THE MAIN DISSEMINATION ACTIVITIES AND EXPLOITATION OF RESULTS**

### **1.4.1.1 Improving prognosis of children with ALL in Europe**

The IntReALL project has set up the largest study group worldwide for treatment of childhood relapsed ALL including mainly European, but also several non-European countries. The IntReALL trials aims at including all paediatric oncology centres in the participating countries, thus warranting a population based patient recruitment. Thus, all patients diagnosed and treated in participating countries will have access to the IntReALL trials. The clinical trials platform allows setting up studies to optimize treatment of these patients and improve prognosis. By this, survival of childhood ALL in general will improve. IntReALL helps making childhood cancer a curable disease.

### **1.4.1.1 Standardized diagnostics and risk factors**

The project has developed and established standardized diagnostic procedures, which are documented in SOP's. Furthermore, a comprehensive network of national reference laboratories has been set up, warranting uniform methodology of complex analyses such as quantification of minimal residual disease by PCR or flow cytology methods. Every child with ALL relapse gets the same and best available diagnostic work up as prerequisite for an adequate stratification and treatment strategy. In particular, the indication for the rather toxic procedure of allogeneic hematopoietic stem-cell transplantation is highly elaborated: only those patients who will not be curable with chemotherapy only are allocated to transplantation.

### **1.4.1.2 Best available standard therapy**

IntReALL has set up trials employing and optimizing the best available standard chemotherapy. The best treatment protocols formerly developed in national settings are now established in a large international consortium. The comparison of the Arm A (ALL-REZ BFM 2002) and Arm B (ALL-R3) in the SR protocol is a unique approach to develop international treatment standards. With this trial, a large variety of chemotherapy elements can be considered standard of care in all participating countries. They can serve as backbone elements for combination trials with new agents. Efficacy and toxicity can be compared in all participating nations and reasons for deviations may be detected and corrected. Patients do not need to travel to a country with the best treatment, because the best treatment is spread over Europe and beyond.

### **1.4.1.3 Development and Integration of new agents**

The IntReALL Consortium is involved in the discussion, prioritization, planning and performance of early clinical trials for development of new agents in childhood ALL. Most of the new agents are targeted against specifically deficient intracellular pathways or aberrantly expressed antigens at the surface of the leukemic cells. Therefore, they apply completely different mechanisms of action and may break resistance of leukemic cells against conventional therapies. Since patients eligible for these trials come from 1<sup>st</sup> relapse trials, the



Consortium can allocate them directly to attractive and open phase I/II trials. These trials intend to test the combination of new agents with standard chemotherapy at an early stage, preferably compatible with the IntReALL treatment elements. This allows selecting the most attractive agents and integrate them into the curative approaches of the IntReALL trials. The new agents may ideally improve the efficacy of the treatment without increasing toxicity or they may replace toxic and unspecific chemotherapy leading to equal outcome with less side effects. The design of these trials is fully driven by academic forces and thus in the best interests of the patients. Children with ALL in Europe and beyond can get access to attractive new agents in a controlled and academically driven way.

#### **1.4.1.4 Reduction of toxicity and long term sequelae**

The integration of new targeted agents into curative treatment strategies and the replacement of toxic unspecific chemotherapy with intelligent personalized new drugs will lead to a reduction of acute and long-term toxicity. The IntReALL trials show, that application of standard chemotherapy is effective and saves the lives of most children with relapsed ALL. However, it results in high acute toxicity as prospectively shown by the pharmacovigilance monitoring and in treatment related mortality rates, which are expected in this patient cohort, but yet not acceptable. Furthermore, long-term sequelae are a relevant burden for children surviving their malignancies. Elements resulting in these acute and long-term side effects are identified, and it is intended to replace them as far as possible. The controlled and well-documented treatment of the IntReALL trials allows to contribute to this development in favour of children with relapsed ALL.

#### **1.4.1.5 Innovative statistical designs**

With the Centre for Statistics in Medicine (CSM), the IntReALL Consortium has gained a partner with expertise in setting up and monitoring the statistical part of a clinical trial. The CSM is actively discussing the statistical designs for the IntReALL trial in the scientific community dedicated to clinical trials statistics. The group has implemented innovative elements in the HR statistical design thereby addressing the poor prognosis of these patients, the reluctance of investigators to treat patients in the standard of care comparator arm and the necessity for flexibility of the trial in the highly dynamic field of ALL treatment. These specific strategies and experiences may serve as example for future trials or trials in other entities.

#### **1.4.1.6 Development for treatment strategies for the whole world**

Diagnostic standards and treatment strategies developed by the IntReALL Consortium are considered as best standard of care by other countries and study groups worldwide. IntReALL experts consult other study groups on setting up local treatment standards. IntReALL has set up a registry tool, allowing centres and countries not participating in the IntReALL trials to document their patients, follow the standardized diagnostic procedures and treat according to published guidelines. From this enlarged cohort, small biological subpopulations with specific targets may be identified and allocated to respective early clinical trials, even beyond the IntReALL Consortium.





#### **1.4.1.7 Infrastructure meeting the high-level requirements on GCP, QM, and regulation**

With the IntReALL FP7 project, a comprehensive infrastructure for international clinical trials in childhood relapsed ALL has been established. With recent legislations, the regulatory, quality management and documentation efforts in clinical trials have reached highest levels. These complex requirements can only be met by a clear structure on comprehensive clinical trial management. On an international level a comprehensive study centre is required including a trial management group, pharmacovigilance, regulatory and legal affairs experts, a data management group and a statistical group; furthermore on a national level a national study is required to take over a substantial part of sponsor responsibilities, in particular the monitoring and national quality control tasks. The infrastructure set up within the FP7 project is used beyond the project to continue and finalize the IntReALL SR and HR 2010 trials, and to set up future studies for this patient cohort.

#### **1.4.1.8 GCP conform comprehensive trial database system MARVIN**

The MARVIN database complies with all requirements of contemporary clinical trials and the good clinical practice (GCP) guidelines. The IntReALL FP7 project gave the opportunity to develop the system in close interaction of the user group with the provider XClinical. Many features have been implemented that are specifically relevant for complex international paediatric oncology trials. The applicability of these features have been proven in the course of the SR trial with more than 350 patients documented in the system. The system has been selected as standard database of clinical trials and registries in more than 20 mostly international trials on childhood oncology diseases. Other trials can benefit from the achievements of the IntReALL project. The MARVIN database has gained such a broad applicability, that most relevant paediatric oncology centres are trained on and gained experience with the system.

#### **1.4.1.9 Reliable partner for industry and regulatory authorities**

The IntReALL Consortium is accepted as competent and reliable partner for industry and regulatory authorities. Pharmaceutical companies are regularly including IntReALL experts into advisory boards to discuss the implementation of early clinical trials and paediatric investigational plans (PIP's). These need to be in the interest of the patients and compatible with the existing academic trial structures. IntReALL experts are also interacting with regulatory authorities, in particular the European Medicines Agency (EMA) to agree on drug development plans and keep regulatory requirements realistic and compatible with the existing structures. A good example is the development of the CD3 and 19 directed bispecific monoclonal antibody Blinatumomab, which has been developed for childhood relapsed ALL in close interaction with IntReALL experts and which, in the meantime, has achieved a licence for childhood relapsed refractory in the US and will get the license for the same indication in Europe soon. It is furthermore randomly investigated within the IntReALL HR strategies and will be investigated in children with primary ALL in the next years.



#### **1.4.1.10 Networking with academic structures**

The IntReALL consortium interacts with other academic groups dedicated to treatment of childhood cancer, childhood ALL and to drug development in children with malignant diseases. IntReALL is represented in the large international and national scientific societies. Within these, IntReALL is the driving force for diagnostics and treatment of childhood relapsed/refractory ALL.

#### **1.4.1.11 Comprehensive international tumour bank**

The project has set up a large virtual international tumour bank. National tumour banks are linked to the SCOPELAND tissue bank and report on availability and quantity of tumour material with a specific set of clinical and biological information. This allows for searching of material for research projects in rare subgroups. Furthermore, the storage and documentation is standardized warranting high quality and reliability of the requested material. All participating experts are allowed to apply for material. The applications are reviewed by an expert panel warranting high quality research and preventing doubling or overlapping projects. In addition, external groups may apply for research with the material as long as patient consent allows and the research is considered important and valuable by the expert panel.

#### **1.4.1.12 Comprehensive translational research programme**

Experts on translational research have set up a programme for investigating childhood relapsed ALL. This includes the optimal use of MRD monitoring with different methods, the investigation on immune effector cells in the course of treatment, the investigation of cytogenetic aberrations and molecular genetic profiles applying different methods. Furthermore, a growing number of candidate genes relevant for pathogenesis, prognosis, and/or targeted therapy, are defined and screened using generation sequencing methods. A comprehensive preclinical drug-testing pipeline has been set up and will be routinely used in the future. Patient derived xenograft models are used for amplification of material and for drug testing projects. The role of the microenvironment of the bone marrow and extramedullary sites is investigated. Results of this comprehensive research can be validated and in case integrated directly into clinical strategies. Patients can benefit from a close collaboration of the clinical trials and the biologic research groups.

#### **1.4.1.13 Dissemination of knowledge and results at national and international congresses**

Results of IntReALL activities are communicated and discussed in scientific working meetings and published in large scientific congresses. The clinical trials are communicated closely to the investigators of the participating centres in national investigator meetings and scientific symposia. The experience of IntReALL experts is disseminated in educatory congresses for students and young doctors on national and international levels, in close cooperation with other academic institution such as the International Society for Pediatric Oncology (SIOP) or the group for Innovative Therapies for Children and Adolescents with Cancer (ITCC). The strategy and results of IntReALL trials are communicated in forums for patients and families such as web sites of charity foundations or national scientific societies.



#### **1.4.1.14 Publication of results in high-level journals**

Results of IntReALL activities are published in peer reviewed journals with high impact and high dissemination effect. Results of trials on childhood relapsed ALL are considered as scientifically important, because this is a rare disease and only few groups are dedicated to this specific patient population.

#### **1.4.1.15 Selecting and investigating new agents in the best interest of the patients**

In the very innovative and dynamic field of drug development driven by commercial interest of pharmaceutical industry, the IntReALL consortium can guarantee the investigation of the most attractive agents and their controlled inclusion into curative treatment strategies free from commercial interest and in the best interest of the patients. The early and close interaction with industry and regulatory authorities allows to guide the development in the right direction and to avoid trials and plans not considering the established high level of treatment and results for the patients. The society in Europe can rely on the fact that drug development in paediatric ALL is controlled by academic experts. Only drugs with a very good rationale and a proven favourable risk/benefit profile will enter clinical trials.

#### **1.4.1.16 Integration of parent's knowledge and interests**

The IntReALL Consortium has included the opinion of parent organizations from the beginning. They have participated in the Ethics Board accompanying the project. They have reviewed the protocols and in particular the consent forms. The parent organizations help to set up the trials in the interests of the patients and to keep the formalities manageable for the families. The voice of the parents is important in the interaction with regulatory bodies in preventing overregulation and undermining clinical practicality.

With integration of parent organizations, IntReALL has brought the treatment of children with relapsed ALL from an exclusive scientific expert community to the middle of the society. The project has shown that the fight for the lives of these extremely sick children is difficult and costly, but can result in the survival of the majority of them.



## **1.5 THE ADDRESS OF THE PROJECT PUBLIC WEBSITE, IF APPLICABLE AS WELL AS RELEVANT CONTACT DETAILS.**

Public website address: <http://www.intreall-fp7.eu>

Contact details:

For all enquiries concerning IntReALL, please contact the project coordinator:

PD Dr. med. Arend von Stackelberg

Charité - Universitätsmedizin

Charitéplatz 1

10117 Berlin

Germany

Tel: + 49-30-450 666 833

Fax: + 49-30-450 666 930

E-mail: [Arend.Stackelberg@charite.de](mailto:Arend.Stackelberg@charite.de)